

# BP601G1 Tech Sheet

---

**Customer:** Balboa Water Group

**Part Number:** 56497-01 800 Incoloy  
56498-01 825 Incoloy  
56499-01 Titanium

Custom Box Overlay

Box Overlay Part Number N/A

CE System Model: BP6-BP601G1-RCA-3.0KW  
Software Version ID: M100\_206 V15.0  
Software Version: 15.0  
File Name: BP601\_15.0\_BP601G1\_2.hex  
Configuration Signature: 63D9CF45

Eng. Project Number: 4127

Base PCBA: 56500-01

Control Panels (See later pages for more information):

TP800 Version 3.1 and later  
TP600CE Version 2.7 and later - TP600 (non-CE) should not be used  
TP400T Version 2.7 and later  
TP400W Version 2.7 and later



Manufactured under one or more of these patents. U.S. Patents: 5332944, 5361215, 5550753, 5559720, 5,883,459, 6253227, 6282370, 6590188, 6976052, 6965815, 7030343, 7,417,834 b2, Canadian Patent: 2342614, Australian patent: 2373248 other patents both foreign and domestic applied for and pending. © Copyright 2009 Balboa Water Group.

**BALBOA**  
water group

# System Revision History

Part #	EPN	Date	Originator	Changes Made
56497 56498 56499	3899	05-13-13	BWG	BP601G1 initial draft
56497 56498 56499	N/A	06-12-13	BWG	Corrections to Tech Sheet
56497-01 56498-01 56499-01	4127	08-28-13	BWG	Issue found with Serialized Purge on one-pump-only Setups.

Manufactured under one or more of these patents. U.S. Patents: 5332944, 5361215, 5550753, 5559720, 5,883,459, 6253227, 6282370, 6590188, 6976052, 6965815, 7030343, 7,417,834 b2, Canadian Patent: 2342614, Australian patent: 2373248 other patents both foreign and domestic applied for and pending. © Copyright 2009 Balboa Water Group.



# Basic Functions Setup 1 - 6

---

## Power Requirements:

**Single Service** [3 wires (line, neutral, ground)]  
230VAC, 50Hz, 1p, 16A, (Circuit Breaker rating = 20A max.)

**Single Service** [3 wires (line, neutral, ground)]  
230VAC, 50Hz, 1p, 32A, (Circuit Breaker rating = 40A max.)

## System Outputs:

Pump 1	230VAC	2-Speed	6.5A - 12A max	15-minute timer (30-minute timer for P1 Low in non-circ setups only)
				Pump size is dependent on service available (16A vs. 32A), other equipment installed, and if A5 is set to ON for Special Amperage Rule B. in Setups 1, 3, 5, this is the heater pump. Must deliver 20 GPM through heater NOTE: A circ pump cannot be used with a 2-speed pump in this system. See the BP601G2. 1 Speed in Setups in Setups 2, 4, 6
Pump 2	230VAC	1-Speed	6.5A - 12A max	15-minute timer
				Pump size is dependent on service available (16A vs. 32A), other equipment installed, and if A5 is set to ON for Special Amperage Rule B. Used in setups 1 & 2
Blower	230VAC	1-Speed	4A max	15-minute timer
				Used in Setup 3 & 4
Circ Pump	230VAC	1-Speed	2A max	Programmable Filtration Cycles + Polling
				This is the heater pump in Setups 2, 4, 6. Must deliver 20 GPM through heater
Ozone	230VAC		.5A max	Slaved to Circ Pump in Circ Setups and to Pump 1 Low in Non-Circ Setups
Spa Light	10VAC	On/Off	1A max	240-minute timer.
A/V (Stereo)	230VAC	Hot	4A max	Always on
Heater	3.0kW @ 240VAC max			

# Hardware Setup

## Wiring Diagram

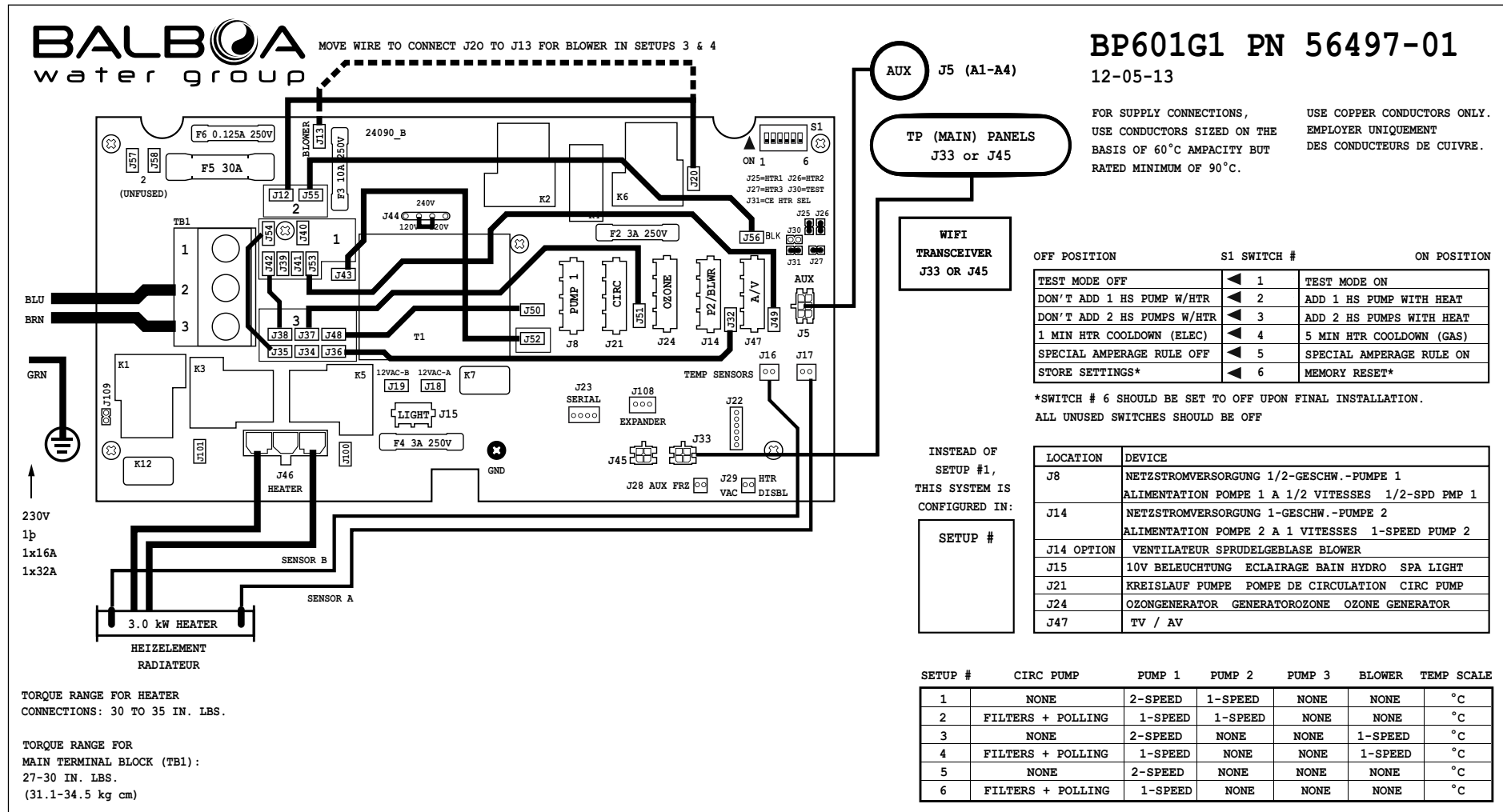

Manufactured under one or more of these patents. U.S. Patents: 5332944, 5361215, 5550753, 5559720, 5,883,459, 6253227, 6282370, 6590188, 6976052, 6965815, 7030343, 7,417,834 b2, Canadian Patent: 2342614, Australian patent: 2373248 other patents both foreign and domestic applied for and pending. © Copyright 2009 Balboa Water Group.

**BALBOA**  
water group

# Setup Reference Table

Setup #	Circ Pump	Pump 1	Pump 2	Pump 3	Blower	Temp Scale
1	None	2-Speed	1-Speed	None	None	°C
2	Programmable Filtration + Polling	1-Speed	1-Speed	None	None	°C
3	None	2-Speed	None	None	1-Speed	°C
4	Programmable Filtration + Polling	1-Speed	None	None	1-Speed	°C
5	None	2-Speed	None	None	None	°C
6	Programmable Filtration + Polling	1-Speed	None	None	None	°C

**System is shipped in Setup 1**

# Changing Software Setups with TP800

## Test Menu Access (S1, Switch 1 ON) *Service Technician ONLY.*

**DANGER! HIGH VOLTAGE WILL BE ACCESSIBLE! SERVICE TECHNICIAN ONLY!**

While the system is running, move DIP Switch 1 (on S1 on the Main circuit board) to ON.  
The system will enter Test Mode.  
Moving DIP Switch 1 to OFF will exit Test Mode.

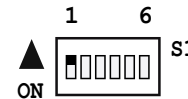

## Software Setups

Under the TEST Menu, the Setup screen will allow changing the Setup from 1 to any number established by the Manufacturer.  
Changing the Setup may require wiring changes as well.

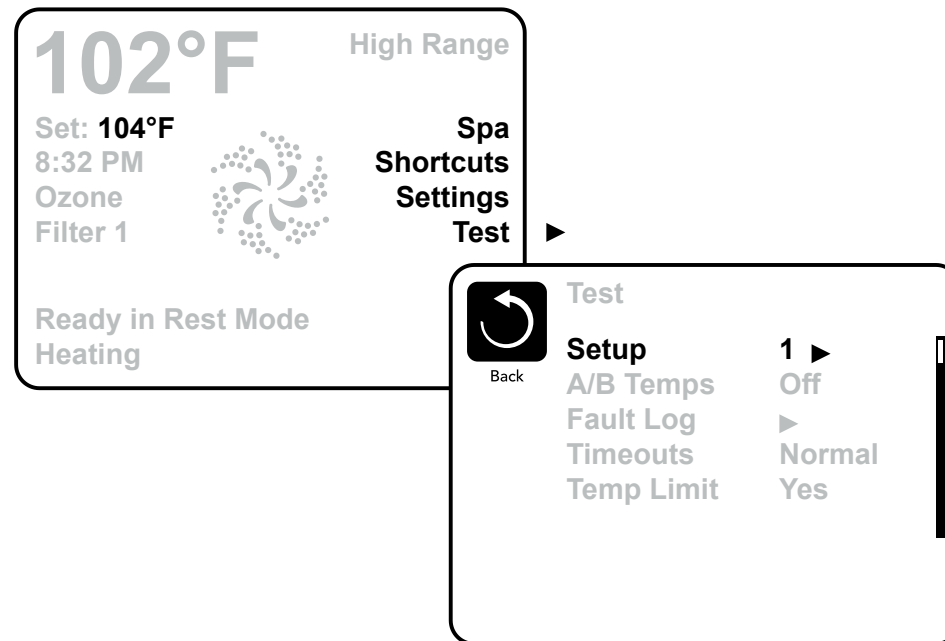

# Changing Software Setups with TP600/400

## Test Menu Access (S1, Switch 1 ON) *Service Technician ONLY.*

**DANGER! HIGH VOLTAGE WILL BE ACCESSIBLE! SERVICE TECHNICIAN ONLY!**

While the system is running, move DIP Switch 1 (on S1 on the Main circuit board) to ON. The system will enter Test Mode. Moving DIP Switch 1 to OFF will exit Test Mode.

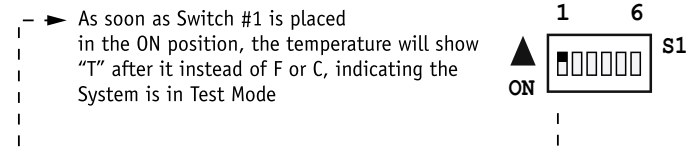

## Software Setups

Under the TEST Menu, the Setup screen will allow changing the Setup from 1 to any number established by the Manufacturer. Changing the Setup may require wiring changes as well.

**You will have 1 minute** to complete the setup change after you manually exit Priming Mode. (Once familiar with the process, the Setup change should take less than 15 seconds.)



When the panel displays RUN PMPS PURG AIR, press any Temperature button ONCE to exit Priming Mode. You should see "---T" where the T indicates the system is in Test Mode.

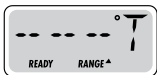

Continued on Next Page.

# Changing Software Setups with TP600/400 Continued

Again, **You will have 1 minute** to complete the setup change after you manually exit Priming Mode.

Immediately after exiting Priming Mode, press this sequence of buttons: Warm\*, Light, Warm, Warm, Warm, Warm. Continue to press Warm until the display shows the Setup Number (S-01, S-02, etc.) you want to switch to. When the correct setup number is showing, press Light once, and the system will reset, using the newly-selected Setup from that point on.

Move DIP Switch 1 to the OFF position to take the spa out of Test Mode. °F or °C will replace °T.

**Using a permanent marker, write the Setup number on the Setup label mounted inside the system lid (right). This is very important to any service person in the future who may need to replace a circuit board or system and needs to change the Setup on a replacement part while in the field.**

NOTE: Changing the Setup may require wiring changes as well - refer to the wiring diagram or wiring diagram addendum.

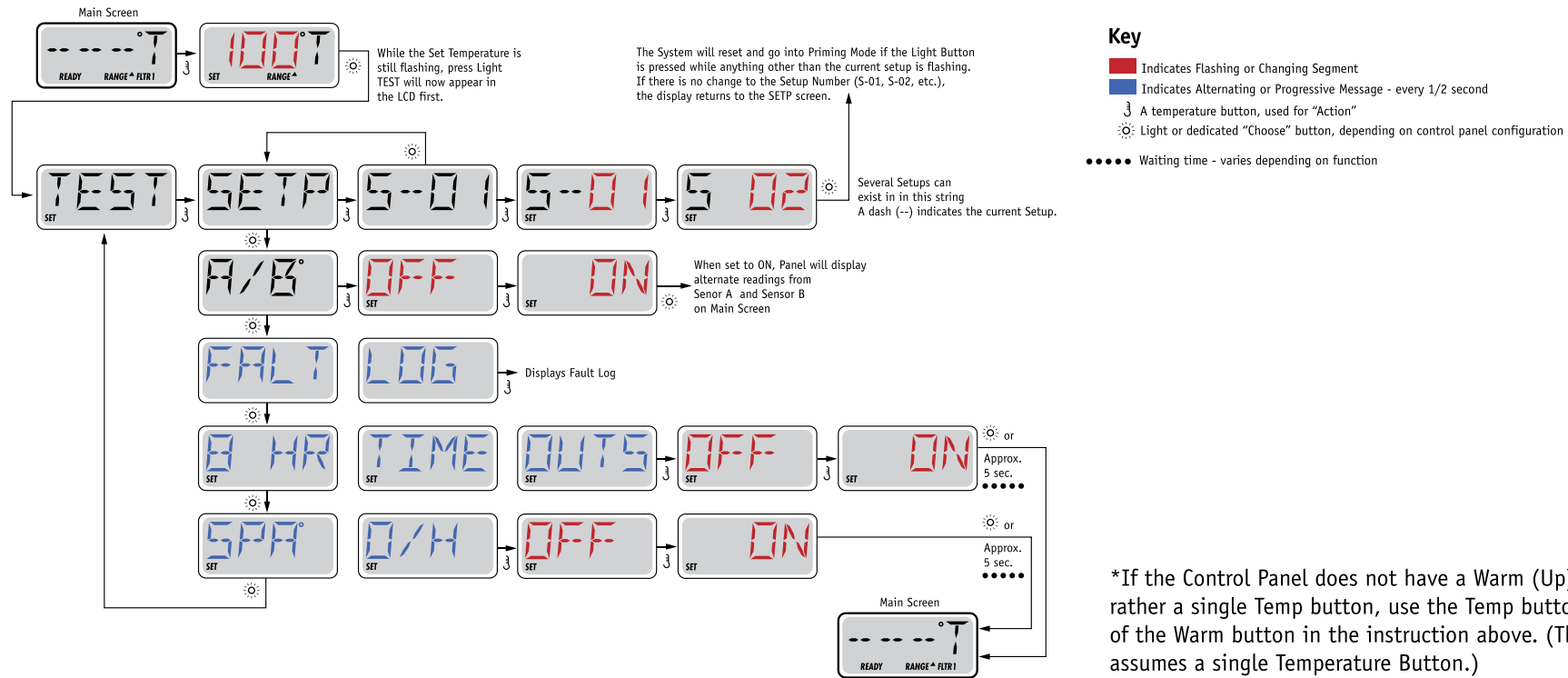
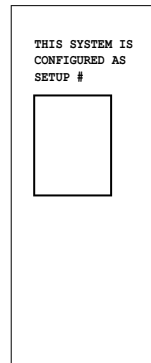



# Equipment Expansion

---

## Expansion Features

### Control Connection

Relay 1/2 (J108)

### Default

None

### Fuse

None

Manufactured under one or more of these patents. U.S. Patents: 5332944, 5361215, 5550753, 5559720, 5,883,459, 6253227, 6282370, 6590188, 6976052, 6965815, 7030343, 7,417,834 b2, Canadian Patent: 2342614, Australian patent: 2373248 other patents both foreign and domestic applied for and pending. © Copyright 2009 Balboa Water Group.



# DIP Switch Functions

---

## Fixed-function DIP Switches

- A1 Test Mode (normally Off).
- A2 In "ON" position, add one high-speed pump (or blower) with Heater.
- A3 In "ON" position, add two high-speed pumps (or 1 HS Pump and Blower) with Heater.
- A5 In "ON" position, enables Special Amperage Rule B. See Special Features section under Configuration Options for functionality with your system.  
In "OFF" position, enables Special Amperage Rule A.
- A6 Persistent memory reset (Used when the spa is powering up to restore factory settings as determined by software configuration).

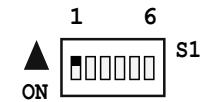

**A2 and A3** work in combination to determine the number of high-speed devices and blowers that can run before the heat is disabled. i.e. A2 and A3 in the ON position will allow the heater to operate with up to 3 high-speed pumps (or two HS Pumps and Blower) running at the same time. Heat is disabled when the fourth high-speed pump or blower is turned on.

**Note:** A2/A3 all off = No heat with any high-speed pump or blower.







---

## Assignable DIP Switches

- A4 In "ON" position, enables a 5-minute cooldown for some gas heaters (Cooling Time B).  
In "OFF" position, enables a 1-minute cooldown for electric heaters (Cooling Time A).

*Undesignated switches are not assigned a function.*

# Jumper Definitions

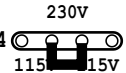
<b>J109</b>	Non Applicable on CE models	J109 
<b>J30</b>	Do Not Use	
<b>31</b>	Jumper on 1 pin with 2.0kW or smaller heater Jumper on 2 pins with a 3.0kW or higher heater	J31 
<b>J29</b>	Heater Disable Switch Connection. If J29 is shorted by any means, the heater will not run until J29 is no longer shorted. If J29 is shorted during power-up “J29” will appear on the panel. The message can be dismissed with a button press, and is the only control panel notification of J29 being shorted. No message is displayed if J29 is shorted after power-up, but the heater will not run until J29 is no longer shorted. J29 expects a switch closure (not a voltage) as the command signal. In some areas, a local power company may offer discounts based on voluntary “power shedding” devices that may be installed in conjunction with the spa.	J29 
<b>J25, J26, J27</b>	Heater Type Settings. <b>Note:</b> <i>Factory Configured do not change.</i>	J25  J26  J27 
<b>J44</b>	Jumper must be on center two pins (230V) for CE Systems.	J44 

## Warning!

Setting DIP switches or jumpers incorrectly may cause abnormal system behavior and/or damage to system components.  
Refer to Switchbank illustration on Wiring Configuration page for correct settings for this system.  
Contact Balboa if you require additional configuration pages added to this tech sheet.

# BP601 Configuration Options

---

## General Features

<b>Feature</b>	<b>Default</b>	
Pump 1 in Filter Cycle (Circ Only)	No	
Pump 1 Low Timer	<i>30 Minutes</i>	Applies in non-circ Setups (configurations) only
General Pump Timer	15 Minutes	
Blower Timer	15 Minutes	
Mister Timer	15 Minutes	
Light Timer	240 Minutes	
Circ (when enabled)	Programmable + Polling	
Cleanup Cycle	<i>30 Minutes</i>	
Cleanup as Preference setting	<i>Yes</i>	
Ozone	With Heater Pump*	
Ozone Suppression	OFF	
Pump Purge	60 Seconds	
Blower Purge	30 Seconds	
Mister Purge	5 Seconds	
Purge Type	Serial - Pumps at lowest speed <i>except Simultaneous Purge for Setup 5</i>	

\* The heater Pump can be either a Circ Pump or Pump 1 Low.

*Blue Indicates New Custom Configuration Default (Setup 1)*

Manufactured under one or more of these patents. U.S. Patents: 5332944, 5361215, 5550753, 5559720, 5,883,459, 6253227, 6282370, 6590188, 6976052, 6965815, 7030343, 7,417,834 b2, Canadian Patent: 2342614, Australian patent: 2373248 other patents both foreign and domestic applied for and pending. © Copyright 2009 Balboa Water Group.

# BP601 Configuration Options

---

## Temperature Features

Feature	Default
Temperature Display	°C, °F

All temperatures must be specified in °F. The system converts °F to °C dynamically. If Celsius is required for default settings, choose a desired °C value that (after rounding) corresponds to a Fahrenheit value.

°C	4	5	6	7	8	9	10	11	12	13	14	15	16	17	18	19	20	21	22
°F	39	41	43	45	46	48	50	52	54	55	57	59	61	63	64	66	68	70	72
°C	23	24	25	26	27	28	29	30	31	32	33	34	35	36	37	38	39	40	
°F	73	75	77	79	81	82	84	86	88	90	91								

Hi-Range Min. Set Temp	80°F
Hi-Range Max. Set Temp	104°F
Hi-Range Default Temp*	100°F
Lo-Range Min. Set Temp	50°F
Lo-Range Max. Set Temp	99°F
Lo-Range Default Temp*	70°F
Freeze Threshold	44°F
Freeze Type	Rotating - Pumps at Lowest Speed
Temp Lock Type	Temp + Settings

\*May be changed by end-user (if enabled)

*Blue Indicates New Custom Configuration Default (Setup 1)*

Manufactured under one or more of these patents. U.S. Patents: 5332944, 5361215, 5550753, 5559720, 5,883,459, 6253227, 6282370, 6590188, 6976052, 6965815, 7030343, 7,417,834 b2, Canadian Patent: 2342614, Australian patent: 2373248 other patents both foreign and domestic applied for and pending. © Copyright 2009 Balboa Water Group.



# BP601 Configuration Options

---

## Time Features

Feature	Default
Time Format*	12 Hour
Filter 1 Start Hour*	20:00 (8:00 PM)
Filter 1 Duration*	2 Hours
Filter Cycle 2 Default*	OFF
Filter 2 Start Hour*	08:00 (8:00 AM)
Filter 2 Duration*	15 Minutes
Light Cycle	Disabled
Light Cycle Default*	OFF
Light Cycle Start Hour*	21:00 (9:00 PM)
Light Cycle Duration*	15 Minutes -or or Disabled
Cooling Time A	1 Minute

*\*May be changed by end-user (if enabled)*

*Blue Indicates New Custom Configuration Default (Setup 1)*

Manufactured under one or more of these patents. U.S. Patents: 5332944, 5361215, 5550753, 5559720, 5,883,459, 6253227, 6282370, 6590188, 6976052, 6965815, 7030343, 7,417,834 b2, Canadian Patent: 2342614, Australian patent: 2373248 other patents both foreign and domestic applied for and pending. © Copyright 2009 Balboa Water Group.



# BP601 Configuration Options

---

Cooling Time B	5 Minutes
<b>Reminder Features</b>	
<b>Feature</b>	<b>Default</b>
Reminders Shown*	<i>Yes</i>
Check pH	<i>OFF</i>
Check Sanitizer	<i>OFF</i>
Clean Filter	30 Days
Test GFCI	<i>65 Days</i>
Drain Water	<i>100 Days</i>
Change Cartridge	OFF
Clean Cover	<i>OFF</i>
Treat Wood	<i>OFF</i>
Change Filter	<i>365 Days</i>

*\*May be changed by end-user (if enabled)*

*Blue Indicates New Custom Configuration Default (Setup 1)*

Manufactured under one or more of these patents. U.S. Patents: 5332944, 5361215, 5550753, 5559720, 5,883,459, 6253227, 6282370, 6590188, 6976052, 6965815, 7030343, 7,417,834 b2, Canadian Patent: 2342614, Australian patent: 2373248 other patents both foreign and domestic applied for and pending. © Copyright 2009 Balboa Water Group.



# BP601 Configuration Options

---

## Special Features

Feature	Default
Special Amperage Rule A	No Limitation
Special Amperage Rule B	1 HS Pump - Blower turns off with 1 HS Pump
Drain Mode	Disabled
Demo Mode	Disabled
Automatic GFCI Test	Disabled
Ozone Slaved to Heater Pump	Yes
Dual Voltage Heater	Always Input Voltage
Safety Suction	Disabled

Manufactured under one or more of these patents. U.S. Patents: 5332944, 5361215, 5550753, 5559720, 5,883,459, 6253227, 6282370, 6590188, 6976052, 6965815, 7030343, 7,417,834 b2, Canadian Patent: 2342614, Australian patent: 2373248 other patents both foreign and domestic applied for and pending. © Copyright 2009 Balboa Water Group.





# TP800 Panel Configuration

**Button Layout Table**

Feature #	Setup 1	Setup 2	Setup 3	Setup 4	Setup 5	Setup 6
A1	N/A	N/A	N/A	N/A	N/A	N/A
A2	Jets 1	Jets 1	Jets 1	Jets 1	Jets 1	Jets 1
A3	Jets 2	Jets 2	Blower	Blower	Light 1	Light 1
A4	Light 1	Light 1	Light 1	Light 1	Invert	Invert
A5	Invert	Invert	Invert	Invert	Undefined	(Circ Icon)
A6	Undefined	(Circ Icon)	Undefined	(Circ Icon)	Undefined	Undefined
A7	Undefined	Undefined	Undefined	Undefined	Undefined	Undefined
A8	Undefined	Undefined	Undefined	Undefined	Undefined	Undefined
A9	Undefined	Undefined	Undefined	Undefined	Undefined	Undefined
A10	Undefined	Undefined	Undefined	Undefined	Undefined	Undefined
A11	N/A	N/A	N/A	N/A	N/A	N/A
A12	N/A	N/A	N/A	N/A	N/A	N/A
A13	Undefined	Undefined	Undefined	Undefined	Undefined	Undefined
A14	Undefined	Undefined	Undefined	Undefined	Undefined	Undefined
A15	Undefined	Undefined	Undefined	Undefined	Undefined	Undefined
A16	Undefined	Undefined	Undefined	Undefined	Undefined	Undefined
B1	Jets 1	Jets 1	Jets 1	Jets 1	Jets 1	Jets 1
B2	Undefined	Undefined	Undefined	Undefined	Undefined	Undefined
B3	Jets 2	Jets 2	Blower	Blower	Undefined	Undefined
B4	Light 1	Light 1	Light 1	Light 1	Light 1	Light 1

# TP800 Panel Configuration

## Spa Screen

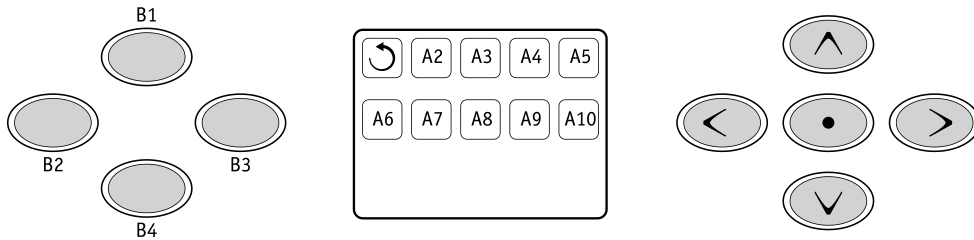

**Note:** Button B2 is ALWAYS unused on TP800 when used with this system. A custom overlay will be required.

## Shortcuts Screen

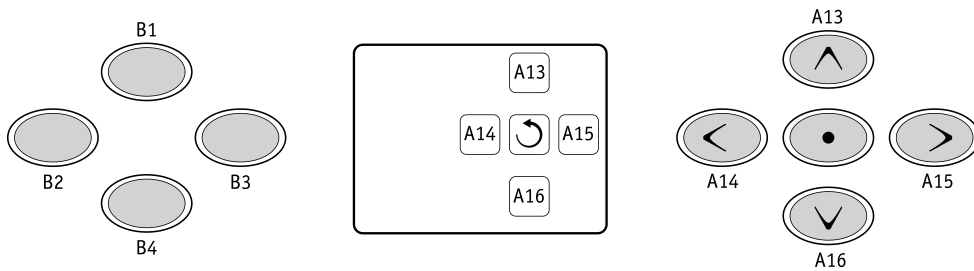

**Note:** Buttons 11 and 12 are not used in this configuration.

Button 1 is fixed.

Panel Part Number      50204-05

Overlay Part Number      N/A

# TP600 Panel Configuration

**Button Layout Table**

Button #	Setup 1 & 2	Setup 3 & 4	Setup 5 & 6
1	Jets 1	Jets 1	Jets 1
2	Jets 2	Blower	Undefined
3	Invert	Invert	Invert
4	Up	Up	Up
5	Light 1	Light 1	Light 1
6	Down	Down	Down
<b>LED 1</b>	Jets 1	Jets 1	Jets 1
<b>LED 2</b>	Jets 2	Blower	Undefined
<b>LED 3</b>	Light 1	Light 1	Light 1
<b>LED 4</b>	Heat On	Heat On	Heat On

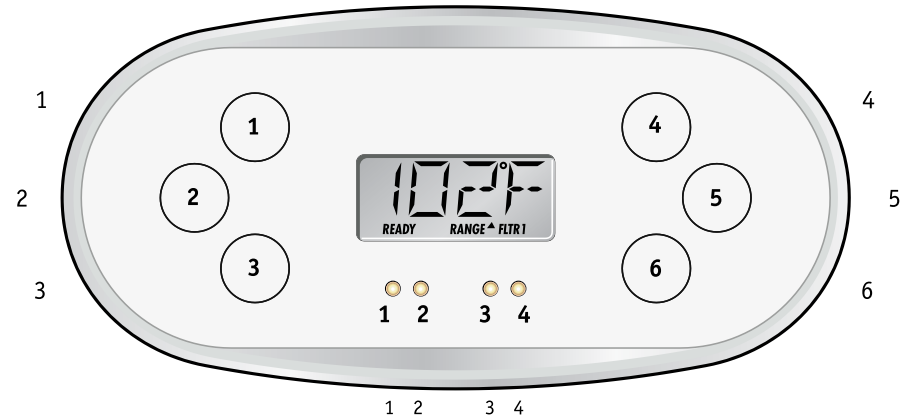

## TP600CE

50015-04 or later

No Overlay

TP600 (non-CE) should not be used.

# TP400 Panel Configuration

**Button Layout Table for TP400T**

Button #	Setup 1 & 2	Setup 3 & 4	Setup 5 & 6
1	Temperature	Temperature	Temperature
2	Jets 1	Jets 1	Jets 1
3	Light 1	Light 1	Light 1
4	Jets 2	Blower	Undefined
LED 1	Heater ON	Heater ON	Heater ON
LED 2	Jets 1 ON	Jets 1 ON	Jets 1 ON
LED 3	Light ON	Light ON	Light ON
LED 4	Jets 2 ON	Blower ON	Undefined

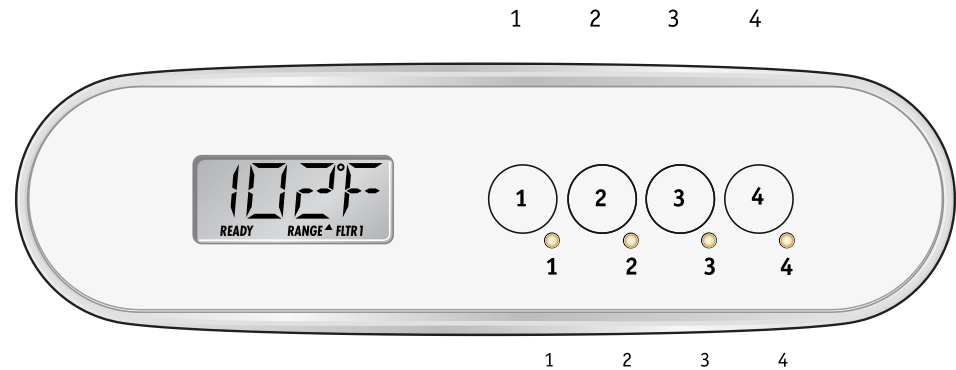

## TP400T

50260-02 or later

Includes overlay PN 12511.

**Button Layout Table for TP400W**

Button #	All Setups
1	Up
2	Down
3	Light 1
4	Jets 1
LED 1	Heater ON
LED 2	Undefined
LED 3	Light ON
LED 4	Jets 1 ON

Use the TP400W for setups that only have one pump (No Blower or Pump 2).

## TP400W

50259-01 or later

Includes overlay PN 12510.

# BP601 Configuration Options

---

## Auxilliary Panel Features on Bank 1\*

Feature	Default
Aux Button A1	Jets 1
Aux Button A2	Jets 2 in Setups 1 & 2 Blower in Setups 3 & 4 Undefined in Setups 5 & 6
Aux Button A3	Undefined
Aux Button A4	Light

\*Bank 1 consists of J5 on the Main Circuit Board.

**Aux Connection Splitter PN25257 may be required.**

Buttons that are assigned to equipment that is not defined in a Setup will not do anything in that Setup.

# BP601 Configuration Options

## Auxilliary Panel Features

### AX10 Panels on Bank 1\*

A1, AX10A1	No O/L	52803
A2, AX10A2	No O/L	52804
A3, AX10A3	No O/L	55805
A4, AX10A4	No O/L	52806

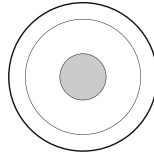

Call Customer Service for additional information about Auxiliary Panels.

Auxiliary Panel Part Number \_\_\_\_\_

Overlay Part Number \_\_\_\_\_

\*Bank 1 consists of J5 on the Main Circuit Board.

**Aux Connection Splitter PN25257 may be required.**

### AX20

AX20 A1A2	No O/L	52800
AX20 A1A3	No O/L	52801
AX20 A1A4	No O/L	52802

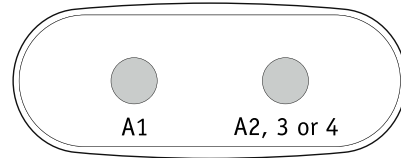

**AX20 Auxiliary Panel plugged into Bank 1 will operate A1 + A2, A3 or A4.**

### AX40

AX40	No O/L	52799
------	--------	-------

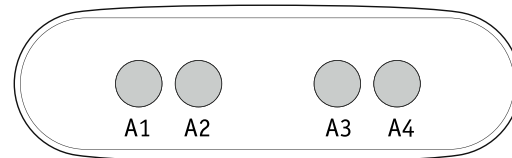

**AX40 Auxiliary Panel plugged into Bank 1 will operate A1 + A2, A3 and A4.**

Manufactured under one or more of these patents. U.S. Patents: 5332944, 5361215, 5550753, 5559720, 5,883,459, 6253227, 6282370, 6590188, 6976052, 6965815, 7030343, 7,417,834 b2, Canadian Patent: 2342614, Australian patent: 2373248 other patents both foreign and domestic applied for and pending. © Copyright 2009 Balboa Water Group.