



**Operating, Installation and Servicing Instructions for
*Indirect fired condensing pool & spa heaters***

Models: MB20S, MB35S, MB50S



Genie

**IMPORTANT : FOR YOUR SAFETY READ THIS
MANUAL BEFORE OPERATING THE HEATER**

RETAIN THESE INSTRUCTIONS FOR FUTURE REFERENCE

Blank page

Contents

Section	Page
1.0 TECHNICAL DATA	4
1.1 User operating and safety instructions	5
2.0 REQUIREMENTS	7
2.1 Pool chemistry	7
2.2 Cleaning	7
2.3 Safety and maintenance	7
2.4 Water temperature settings	7
2.5 Winterisation	7
2.6 Gas safety regulations	8
2.7 Location of heater	8
2.8 Gas supply	9
2.9 Gas conversion	9
2.10 Flueing	9
2.11 Air supply	9
2.12 Outdoor heaters	9
2.13 Flue terminal positions	10
2.14 Condensate drain	11
2.15 Pool pump and pipe work	11
2.16 Electricity supply	11
3.0 INSTALLATION OF HEATER	12
3.1 Procedure	12
3.2 Outdoor terminal	12
3.3 Other flue systems	12
3.4 Wall terminal	12
3.5 Heater & terminal dimensions	13
3.6 Flue examples and flue kit part codes	15
3.7 Terminal guard and roof terminal	17
3.8 Pool water plumbing	17
3.9 Condensate connections	17
3.10 Electrical connections	19
3.11 Gas connection	19
3.12 Wall mounting kit	20
3.13 Multiple heater kit	22
4.0 COMMISSIONING	24
4.1 Removal of primary air	24
4.2 Prior to burner operation	25
4.3 Pool water pressure switch	25
4.4 Conversion to LPG	25
4.5 Commissioning the burner	26
4.6 User setup mode	27
5.0 FAULT FINDING	28
5.1 Operation, safety controls & lockouts	28
5.2 Setup modes	28
5.3 Fault codes & diagnostics	29
5.4 Schematic wiring	32
6.0 SERVICING	33
6.1 Routine servicing	33
6.2 Changing components	34
6.3 Spares	36
6.4 Heater components illustrations	36
7.0 INSTALLATION & SERVICE HISTORY	38

1.0 TECHNICAL DATA

GENERAL SPECIFICATIONS		
WATER CONTENT	MB20S & MB35S/MB50S	5.0 Litres / 6.0 Litres
WEIGHT (net)	MB20S & MB35S/MB50S	53 kg / 55kg
DIMENSIONS, OVERALL		375 mm wide, 520 mm deep, 980 mm high
SERVICE CLEARANCE		300mm Left, Right and Above. 800 mm In front
CORE DRILL DIAMETER		175 mm
MINIMUM FLOW RATE	MB20S	50 l/m (3.0 m ³ /h) or 11.0 gpm
RECOMMENDED FLOW RATE	MB35S	80 l/m (4.8 m ³ /h) or 17.6 gpm
MAXIMUM FLOW RATE	MB50S	120 l/m (7.2m ³ /h) or 26.4 gpm)
MAX PRIMARY WATER PRESSURE		2½ bar (37 psi)
INTERNAL PUMP SETTING		Speed 3
MAXIMUM POOL TEMP		Pool 32°C (90°F) Spa 41°C (106°F)
ELECTRICAL SUPPLY		230V 50Hz, FUSED AT 5A, 130W
PROTECTION LEVEL		IP44
FLUE SYSTEM		80/125 PP, to a max. Flue Equivalent Length of 20m

PERFORMANCE SPECIFICATIONS								
GAS CATEGORY, TYPE AND SUPPLY PRESSURE II _{2H3P} G20 @ 20 mbar G31 @ 37 mbar								
MODEL Corgi Work Code	NATURAL GAS			PROPANE				
	MB20S TBA	MB35S 1036909	MB50S 1036910	MB20S TBA	MB35S 1036913	MB50S 1036914		
HEAT INPUT	GROSS	kW Btu/h	21.5 73,305	38.0 129,650	51.5 179,100	23.1 78,941	38.0 129,650	51.5 179,100
NET		kW Btu/h	19.5 66,392	34.2 116,700	46.4 158,300	21.3 72,842	35.0 119,400	47.5 162,000
TYPICAL EFFICIENCY		% gross % net	92 - 94 102 - 104	92 - 94 102 - 104	92 - 94 102 - 104	92 - 94 102 - 104	92 - 94 102 - 104	92 - 94 102 - 104
HEAT OUTPUT		kW Btu/h	20.0 68,175	36.9 121,870	50.0 165,170	21.5 73,415	36.9 121,870	50.0 165,170
GAS RATE (NG, Propane)		m3/h	1.98	3.45	4.64	0.87	1.43	1.9
MAXIMUM RATE, COMBUSTION SETTINGS, NG,		CO ppm CO2 %	20 - 60 8.7 - 9.0	120-150 9.2 - 9.4	80-120 9.0 - 9.4	35 - 70 9.9 - 10.1	130-160 10.3 - 10.5	100-130 10.0 - 10.3
OFFSET SETTING		pA	-3.0	-3.0	-3.0	-3.0	-3.0	-3.0
ORIFICE		mm	Not required			4.4	4.4	5.2

GB, IE

1.1 USER'S OPERATING INSTRUCTIONS



FOR YOUR SAFETY READ BEFORE OPERATING



DO NOT use this heater if any part has been under water. Call a qualified service engineer to inspect the heater and its gas controls.

There are **NO** user serviceable parts inside this appliance. **DO NOT** interfere with any sealed components.

BEFORE OPERATING after a prolonged time off, Check all around the appliance area for the smell of gas.

WHAT TO DO IF YOU SMELL GAS

- Do not try to light any appliance
- Do not touch any electric switch
- Do not use any phone in your building
- Immediately call your gas supplier from a neighbour's phone. Follow the gas supplier's instructions.
- If you cannot reach your gas supplier, call the fire service.
- Isolate the appliance with the Service Cock immediately next to this appliance. If this is not accessible, isolate at the gas meter.

IMPORTANT SAFETY INFORMATION

- Drinking alcoholic beverages before or during spa or pool use, could cause drowsiness or physical impairment and significantly increases the risk of drowning.
- Persons taking medications which induce drowsiness should not use spas or pools.
- Persons with a medical history of heart disease, circulatory problems, diabetes, epilepsy or blood pressure problems should seek medical advice before using pools or spas.
- Spa or pool temperatures should never exceed 40°C (104°F). 38°C (100°F) is considered safe for a healthy adult. Check the water temperature using an accurate thermometer before entering the pool or spa.
- **Pregnant Women Beware!** Soaking in water hotter than 39°C (102°F) can be especially dangerous during the first three months of pregnancy

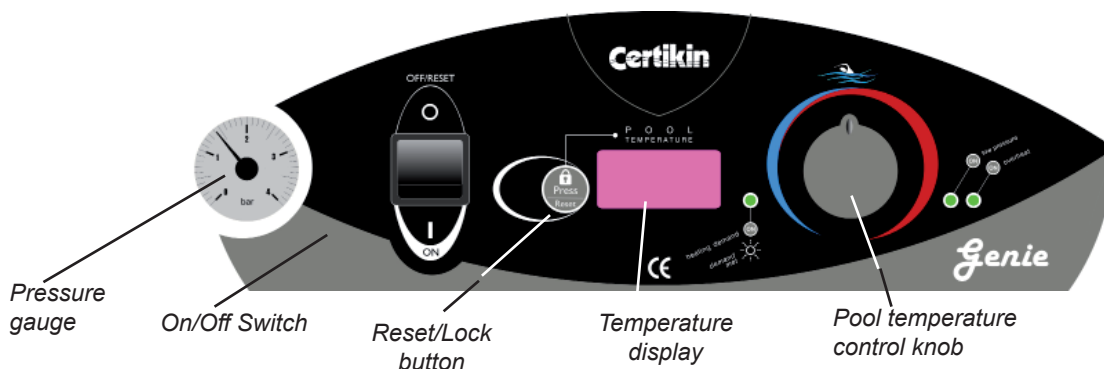

Before Start Up

Pool water must be flowing through the heater and the pressure gauge must be showing between 1.0 and 2.5 bar for it to operate

Quick Start

Check that the electricity and gas supplies are turned on. Turn on the pool pump. Using the switch on the front fascia turn on the heater. Adjust the pool temperature set point using the pool temperature control knob. Within a few seconds the heater will begin its ignition sequence.

Summary of Controls (Left to Right)

Pressure Gauge - This should normally be between 1.5 to 2.0 bar, re-pressurise if too low.

ON/OFF Switch - Turns the heater On and Off.

Lock/Reset Button - If it is pressed for 2 seconds it locks the pool temperature setpoint so the pool temperature knob is inoperative. To unlock, press again for 2 seconds. When locked a short press flashes the set temperature. It also resets gas control lockouts, GAS and OH2.

Pool Temperature Display - This normally shows the pool temperature but also shows the pool set point when the pool temperature control knob is rotated. The display is also used for commissioning and diagnostic purposes. (see 5.2 for details)

If the display alternates the temperature with 'SEr' it is recommended that the heater is serviced. In the mean time the heater will continue to function.

Pool demand LED - Green

Off - There is no pool heating demand.

On - There is pool heating demand and the pool temperature is below set point.

Flashing - The pool heating demand is met, the pool temperature is at or above set point.

Pool temperature control knob

16°C to 32°C (60°F to 90°F)

(Maximum is changed in setup mode, see 5.2)

Rotate clockwise to increase the pool temperature.

The temperature set point is shown whilst rotating the control knob and when released flashes 3 times to confirm setting.

To lock the required temperature set point see 1.1

Pool Pump & primary system pressure

- **Yellow LED, display = pool temperature**

On - If the pool pump is operating and there is insufficient flow pressure, possibly due to a blocked pool filter, the heater will not operate.

On - If the internal primary system pressure has dropped below 1.0 bar, the heater will not operate. Refill the system and check for leaks.

Overheat - Flashing red LED, display = OH2

Flashing - This indicates the heater has overheated and it has shutdown. Wait for the heater to cool then press the Lock/Reset button to start the heater again. If this problem persists this should be investigated by a service engineer.

Overheat - Red & Yellow LED, Display = GAS

On - This indicates the heater ignition control has locked out. Press the Lock/Reset Button to start the heater again. If this problem persists this should be investigated by a service engineer.

Condensate - Display = HI

This indicates that the condensate drain is blocked and the heater has shutdown. When the blockage is cleared, the heater will operate again.

Pool water pressure switch

A water pressure switch is provided in the heater to shut off the burner in the event that pool water flow is interrupted. The water flow pressure switch should be checked and adjusted for proper operation by a qualified service person at the time of installation, and thereafter checked at each service.

Internal water pressure switch

A water pressure switch is provided in the primary water circuit of the heater, to shut off the burner in the event that no primary circuit water exists or is at very low pressure. When the primary water pressure is re-established the heater will operate again.



IMPROPER USE

This appliance has been designed and manufactured to comply with the current European standards of safety. However, following an improper use, dangers could arise concerning the safety and life of the user or of other people, or damage could be caused to the appliance or other objects. This appliance is designed to be used in a pumped swimming pool or spa heating system. Any other usage of this appliance will be considered improper.

Certikin declines any responsibility for any damage or injuries caused by an improper use. In order to use the appliance according to its designed scope, it is essential to carefully follow the instructions given in this manual.



USER COMPETENCY

This appliance is not intended for use by persons of reduced physical, sensory or mental capabilities, or lack of experience and knowledge, unless they are given supervision or instruction concerning the use of it by a person responsible for their safety. Children under the age of 12 should not be permitted to use this appliance.

2.0 REQUIREMENTS

These instructions cover a range of indirect, floor mounted, gas fired, condensing pool heaters which are room sealed and fan assisted. The flue system available is concentric, left, right, rear, and vertical, all up to 20 metres 'FEL'. There is also an outdoor top terminal for use where the heater is installed out of doors. The ignition system is fully automatic.

There are three models with different outputs (see 1.0 for details). These models can be installed in multiples to obtain a larger, combined output.

2.1 POOL CHEMISTRY

This heater uses a high performance cupro nickel heat exchanger and are suitable for connection to pools using chlorinated and salt chlorinated water provided the following levels of chemicals are maintained:-

pH	7.2 to 7.8
Alkalinity	100 to 150 ppm
Calcium Hardness	200 to 400 ppm
Salt concentration	< 30,000ppm
Free Chlorines	1 to 4 ppm
Bromine	2 to 4 ppm
Chlorine	< 150 ppm

All chemicals must be introduced and completely diluted into the pool water before being circulated through an operating heater. Do not place chlorine tablets or bromine sticks in the skimmer, high chemical concentrations will result when the pump is not operating. Turn the heater off when shock dosing

Chlorinators must feed downstream of the heater & have an anti-siphoning device to prevent chemical back-up into the heater when the pump is shut off.

 **High chemical concentrates from feeders and chlorinators that are out of adjustment will cause corrosion to the heat exchanger inside the heater. Such damage is not covered under the warranty.**

2.2 CLEANING

It is recommended that periodically the casing is cleaned and sprayed with WD40 or similar liquid, and any exposed threads are lightly coated in grease.

2.3 SERVICE & MAINTENANCE

It is recommended that the Heater is serviced every 2000 hours of operation, or at least every 12 months. The display will alert when you when it reaches this period by its display, 'SEr' alternating with the temperature.

2.4 WATER TEMPERATURE SETTINGS

The heater is designed to provide maximum heat output up to 1°C below set point. Output is gradually reduced over the last 1°C. If the pool is used before the temperature reaches set point, the water entering the pool from the heater may be noticeably warmer than the pool water. This is not a fault but part of the design. It will reduce for the final 1°C up to set point.



Operation without pool water circulation will cause long term and severe damage to the heater.

2.5 WINTERISATION

Anti-freeze Inhibitor

As supplied this heater includes a dose of Sentinel X500 anti-freeze/inhibitor. Subject to not being removed or diluted, the appliance is protected to -10°C. If the primary circuit of the appliance is drained for any reason, the correct quantity of new anti-freeze/inhibitor must be added to give the level of protection required.

To add anti-freeze/inhibitor to the heater, it is recommended that it is introduced into the side vent after the primary system has been de-pressurised.



As antifreeze/inhibitor is introduced via the side vent the top vent can be opened to minimise air venting (see 4.1 for details on venting).

Swimming pool water

With the exception of heating the water and/or keeping the pool pump operating 24 hours per day, pool water can not be protected against freezing.

If the above methods are not adopted in the winter months, it is recommended that the pool water is completely drained from all pipe work and the secondary heat exchanger.

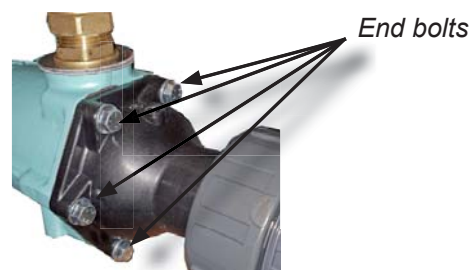

To completely remove pool water from inside the secondary heat exchanger it may be necessary to undo the 6 bolts from one end of the heat exchanger to allow the water inside to run out.



Failure to follow these guidelines could cause damage to the heater which will not be covered by warranty.

2.6 GAS SAFETY REGULATIONS

General

It is the law that all gas appliances are installed by a competent person (e.g. a Gas Safe registered engineer) in accordance with the Gas Safety Regulations. Failure to install appliances correctly could lead to prosecution.

It is in your own interest, and that of safety, to ensure that the law is complied with. The installation of the heater **MUST** also be in accordance with the current I.E.T. Wiring Regulations, the Local Building Regulations, Building Standards (Scotland), the Bye Laws of the Local Water Undertaking, any relevant requirements of the Local Authority.

Detailed recommendations are contained in the following British Standard Codes of Practice.

CODES OF PRACTICE

BS.6798 Installation of gas fired hot water boilers of rated input not exceeding 70kW.

BS.5440: Part1 and Part 2. Flues (for gas appliances of rated input not exceeding 70kW).

BS 6891 Specification for installation of low pressure gas pipework.

BS5482:1 Code of practice for domestic butane & propane gas burning installations.

Building Regulations Part L1.



IMPORTANT.

No external control devices should be directly connected to this appliance - unless covered by these 'Installation and Servicing Instructions' or otherwise recommended by the manufacturer. If in doubt, please enquire.

Any direct connection of a control device not recommended by the manufacturer could infringe the Gas Safety (Installation & Use) Regulations, the above regulations and the normal appliance warranty.

Manufacturer's notes must **NOT** be taken, in any way, as overriding statutory obligations.

2.7 LOCATION OF HEATER

This heater **MUST** be installed on a flat and level floor, capable of adequately supporting the weight of the heater and any ancillary equipment. Provision is provided for the heater to be fixed to the floor.

It is IP 44 Rated and can be installed out of doors in a suitable position. In all cases the choice of position should take into account the flue, the plume and the condensate drainage.



IMPORTANT

If the heater is to be fitted in a timber framed building please refer to "IGE/UP7 Gas installations in timber framed buildings" for guidance

The heater may be installed in any room or internal space. Particular attention is drawn to the requirements of the current I.E.T. Wiring regulations (currently 18th edition)

Where installation will be in an unusual location then please refer to the guidance given in "BS 6798 Specification for selection, installation, inspection, commissioning, servicing and maintenance of gas-fired boilers of rated input not exceeding 70kW". Details of essential features of cupboard compartment design are also to be found in this standard.

Any compartment used to enclose this heater **MUST** be designed and constructed specially for this purpose. An existing cupboard, or compartment, may be used provided it is modified for the purpose.

In siting the heater, the following limitations **MUST** be observed:

1. The position selected for installation **MUST** allow adequate space for servicing in front of the boiler and for air circulation around the boiler.
2. This position **MUST** also permit the provision of a satisfactory balanced flue termination.
3. This position **MUST** also permit the provision of a satisfactory connection to the condensate drain.

2.8 GAS SUPPLY

An existing meter and pipework should be checked, preferably by the Gas Supplier, to ensure that they are adequate to deal with the rate of gas supply required.

Supply pipes should be sized to suit the installation and obtain a working pressure of 20 mbar (for natural gas), 37 mbar (for propane) and 29 mbar (for butane). Installation pipes should be fitted in accordance with BS.6891.

2.9 GAS CONVERSION

This heater is supplied setup for Natural Gas (G20) It can be converted to LPG by the addition of an orifice which is supplied with the heater (*see 1.0 for the setup data & 4.4 for conversion instructions*).

2.10 FLUEING

Only flue components specified by the manufacturer should be used with these appliances. Detailed recommendations for flueing are given in "BS.5440-2 Flueing and ventilation for gas appliances of rated input not exceeding 70kW". The following notes are intended for general guidance:

1. Be aware of the plume from the flue and the wetting effect it can have to adjacent property (*refer to 3.2 & 3.3 for advice*).
2. The flue can be taken upwards, left, right or to the rear of the appliance, but **never** downwards.
3. This heater is supplied separate to the chosen flue set. It can be fitted with up to 20 metres equivalent length of concentric flue (*see 3.0 to 3.6 for advice and parts selection*).



WARNING

It is absolutely **ESSENTIAL** to ensure in practice, that the products of combustion discharging from the terminal cannot re-enter the building, or any other adjacent building, through ventilators, windows, doors, other sources of natural air infiltration or forced ventilation/air conditioning.

If this should occur, the appliance MUST be turned OFF IMMEDIATELY and a Gas Safe engineer consulted.

2.11 AIR SUPPLY

It is NOT necessary to have a purpose provided air vent in the room or internal space in which the boiler is installed. Where the boiler is installed in a cupboard or compartment **no** air vents are required.

However, it is recommended that the space is ventilated to provide air circulation around the heater.

2.12 OUTDOOR HEATERS

This heaters is suitable for outdoor installation, when equipped with the approved terminal.



WARNING

Please note the following advise when locating a heater outdoors:

- Do not locate this heater in an area where water sprinklers, or other devices, may cause water to spray through the cabinet openings and into the inside of the heater.
- Do not locate this heater directly below roofing overhangs (even guttered roofs) where there is a potential for large flows of water to pour directly onto the top of the heater.

Failure to follow the advice above could cause heavy internal rusting or damage some electrical components, and this would void the warranty.

It is recommended that periodically the casing is cleaned and sprayed with WD40 or similar liquid, and any exposed threads are lightly coated in grease.

2.13 FLUE TERMINAL POSITIONS

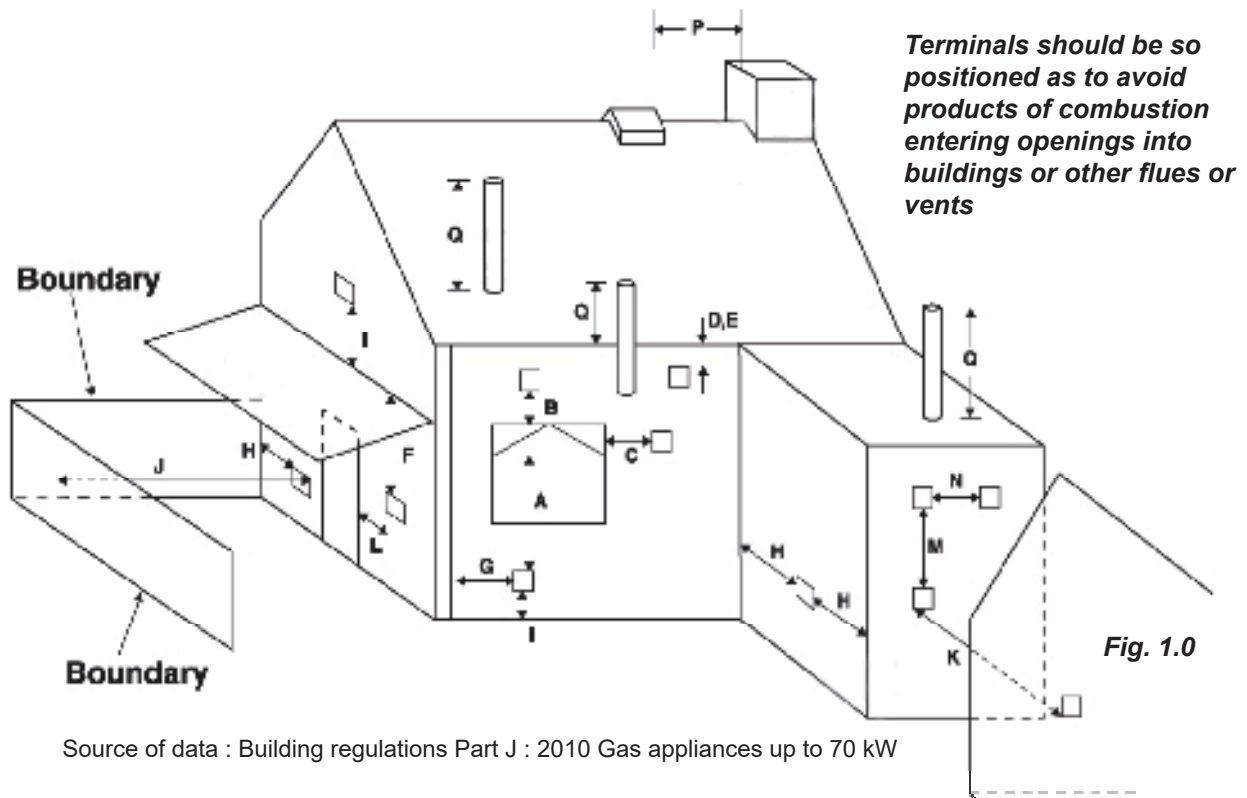

Source of data : Building regulations Part J : 2010 Gas appliances up to 70 kW

Minimum Distance	mm
A Directly below an opening, air brick, opening window etc	300
B Above an opening, air brick, opening window etc	300
C Horizontally to an opening, air brick, opening window etc	300
D Below gutters, soil pipes or drainpipes	75*
E Below eaves	200
F Below a balcony or car port roof	200
G From vertical drain or soil pipe	150
H From an internal or external corner or to an alongside boundary	300
I Above ground, roof or balcony level	300
J From a surface or a boundary line facing a terminal	600
K From a terminal facing a terminal	1200
L From an opening in a carport (e.g. door, windows) into the building	1200
M Vertically from a terminal on the same wall	1500
N Horizontally from a terminal on the same wall	300
P From a roof structure	N/A
Q Above the highest point of intersection on a roof	1200

Terminal adjacent to windows or opening on pitched and flat roofs

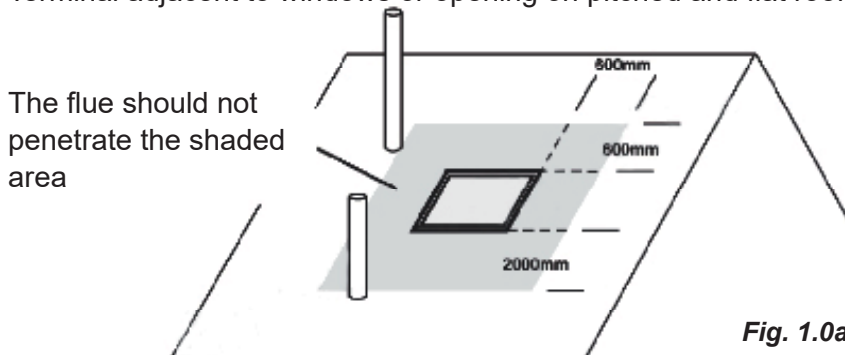

* Only if combustible material is protected. Otherwise a clearance of 600mm should be allowed.

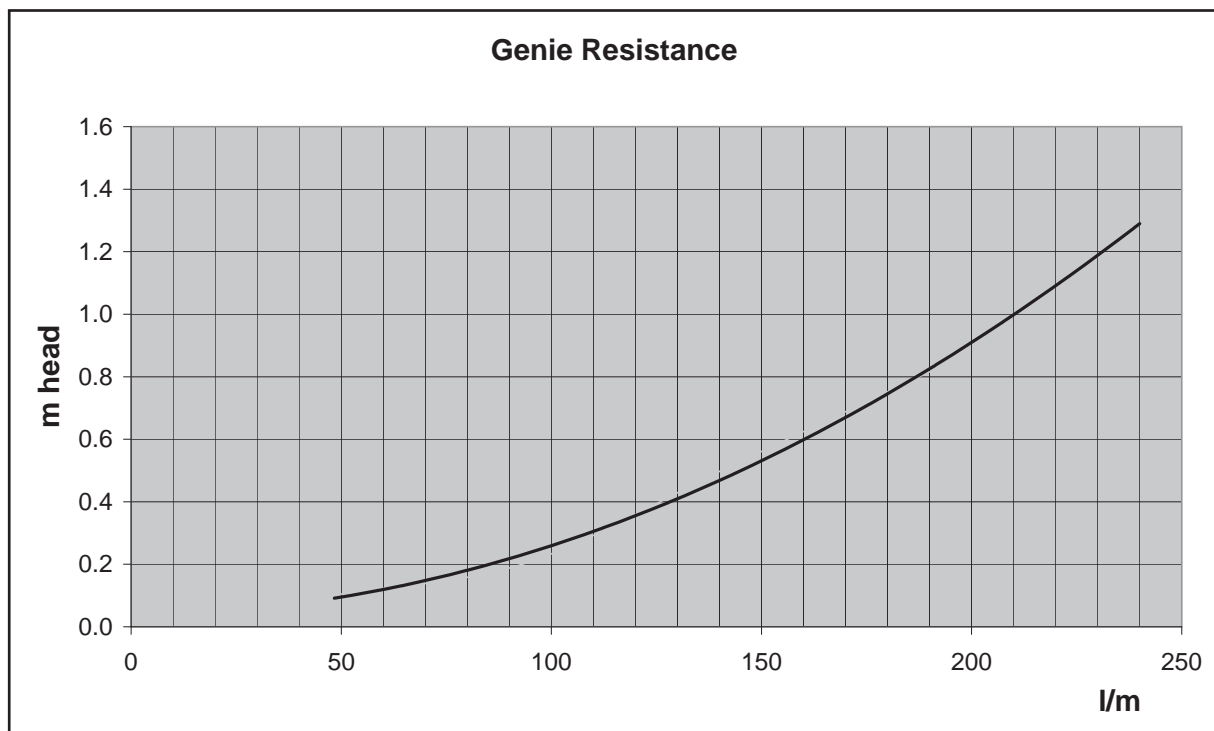

Fig. 2.0

2.14 CONDENSATE DRAIN

(see 3.9 for details)

A 75mm condensate trap is provided on this heater and is satisfactory when connected to soakaways, gullies, rainwater pipework and internal drainage systems. All pipework and fittings in the condensate drainage system **MUST** be made of plastic, unless they carry other liquid waste. **No other materials may be used.** The pipework should be insulated if run out of doors.

The drain outlet on the boiler is :

40 mm Hunter waste pipe.

2.15 POOL PUMP & PIPE WORK

This heater is an indirect design and uses two very high performance heat exchangers. The pool water passes through the secondary, the water in the primary is completely separate. This heaters controls modulate the input when approaching the set temperature for greater accuracy and economy. It is recommended that pool pump overrun is used to maximise the life of this heater.

If a new pump is being fitted consult the pressure loss graph (**Fig 2.0**) to determine its size. This heater is provided with 1½" plastic pool connections. As built the connections are 'From Pool' on the left, 'To Pool' on the right, however these can be easily reversed.

With the exception of automatic dosing equipment, this heater should be plumbed as the last piece of equipment before the pool.

It is permissible to fit an isolating valves on the pipe-work on either side of the heater. In these circumstances it is recommended to fit a flow switch in the heaters mains supply.

2.16 ELECTRICITY SUPPLY

Wiring external to the appliance **MUST** be in accordance with the current I.E.T. Wiring Regulations and any Local Regulations that apply.

This heater is supplied with a plug and lead for 230V ~ 50Hz. Single phase. Fuse rating is 5A.

The method of connection to the mains electricity supply **MUST** facilitate complete electrical isolation of the heater, preferably by the use of a fused double pole switch having a 3mm (1/8in.) contact separation in both poles and servicing only the heater and its controls.

The point of connection to the mains should be readily accessible and adjacent to the heater.

3.0 INSTALLATION OF HEATER

Space required for installation and servicing:

Left, right and above	300mm
Front	800mm

3.1 PROCEDURE

Site to suit the pool, terminal, plume and condensate drain limitations. The terminal position should follow BS 5440 and be at least 600mm away from any opening or obstacle.

1. **For an indoor installation only** : Mark & drill flue hole. (See 3.5 for dimensions)
2. Fix the heater to the floor using the holes provided in the front channel.
3. This heater is provided with a three pin plug and lead. This can be connected to a suitable power supply.

If it is required to operate this heater using an external time clock follow the guidance below :

- Remove front top panel after releasing the retaining M5 screw under the lip.
 - Remove the electrical Cover to access the mains connector.
 - Pull out the mains connector and replace the mains lead and link wire with a permanent and switched live supply (see 5.4). Pipe to the 22mm gas connection.
5. Plumb to the pool pump and filter.
 6. Fill primary system with water using the supplied hose connector. This heater is supplied with one litre of Sentinel X500 Inhibitor/ Anti-Freeze in the pipework.
 7. **IMPORTANT.** It is essential that all air is removed from the primary system through use of the air vent on the right-hand side panel and the vent on the top of the primary heat exchanger (see 4.1 for details).
 8. Test for leaks.
 9. Replace the electrical cover and panels.

3.2 OUTDOOR TERMINAL

A specific outdoor top terminal must be used for an outdoor installation. There must be at least 600mm clearance around the terminal and complete clearance above. The outdoor top terminal is a push fit into the flue adapter and locked in position with a clamping ring. (See 3.2 for details)



If lubrication is required only Centra Cerin or silicone grease should be used.



Fig. 3.0

3.3 OTHER FLUE SYSTEMS (inc FEL)

The maximum Flue Equivalent Length (FEL) permitted is 20 metres, horizontal or vertical. The component parts have the following FELs:

1 metre of concentric flue	1.0
2 metres of concentric flue	2.0
A 45 degree concentric bend	1.1
A 90 degree concentric bend	1.5
A concentric Roof Terminal	3.3
A concentric Wall Terminal	3.9



Sum of the Flue Equivalent Lengths used in the design must not exceed 20 metres.

All items assemble by a push fit/clamp system. If it is required to lubricate the seals only Centra Cerin supplied by the manufacturer or silicone grease should be used. The pipes should be assembled so the socket end is always furthest from the heater. Flues should be supported by brackets every metre of run. Horizontal flues should incline back to the heater by 3 degrees (5mm in 100mm)

3.4 WALL TERMINAL

The horizontal wall terminal is supplied with two rubber wall plates, one for inside and one for the outside. The core drill diameter required is 175mm and should incline upwards to the outside.

Because of the incline the height of the centre of the flue hole on the wall is determined by the distance of the heater from it. Calculate as follows:

1. Ensure service clearance is available.
2. Fit the 90 degree elbow to the heater and measure from its outlet face to the wall.
3. Add 5 mm for every 100 mm distance.
Example: Distance measured = 480 mm
 $(5 \times 480) / 100 = 25 \text{ mm}$
Flue centre $1065 + 25 = 1090\text{mm}$

If it is required to reduce the length of the terminal the minimum overall length is 300mm. The flue duct should be cut 10mm longer than the air duct.

3.5 HEATER DIMENSIONS

Pipe Connections & Locations

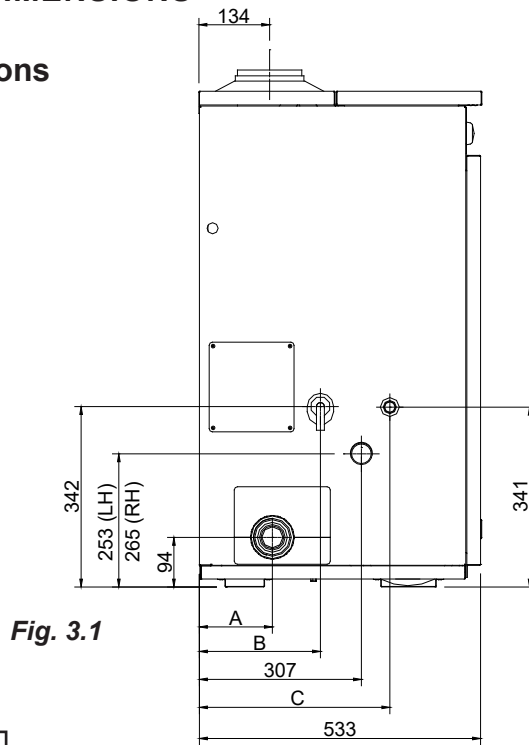
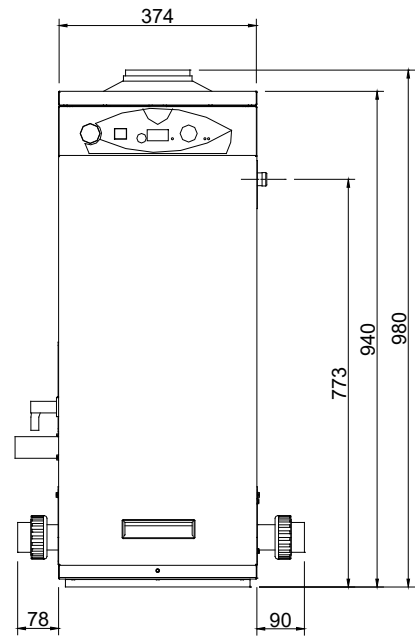

Fig. 3.1



Dimensions			
Model	A	B	C
<i>Genie 20 / 35</i>	138mm	226mm	361mm
<i>Genie 50</i>	170mm	258mm	425mm

Service Access	
Left, Right or Above	300mm
In Front	800mm

Connections	
D	Multi Heater Connection
E	Electric & External Control (CCP01)
F	Gas Supply - 22mm Copper
G	Safety Valve Outlet - 15mm Copper
H	Condensate Drain - 1¼" or 40mm Hunter Plastic
I	From Pool - 1½" Plastic Demountable Fittings

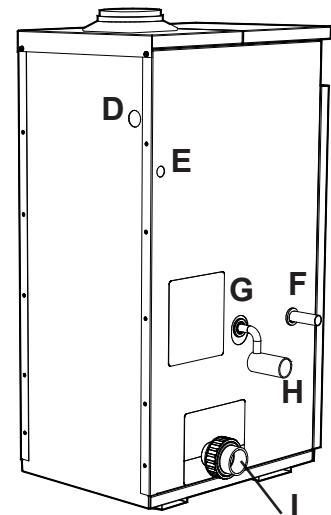

Horizontal Wall Terminal Dimensions

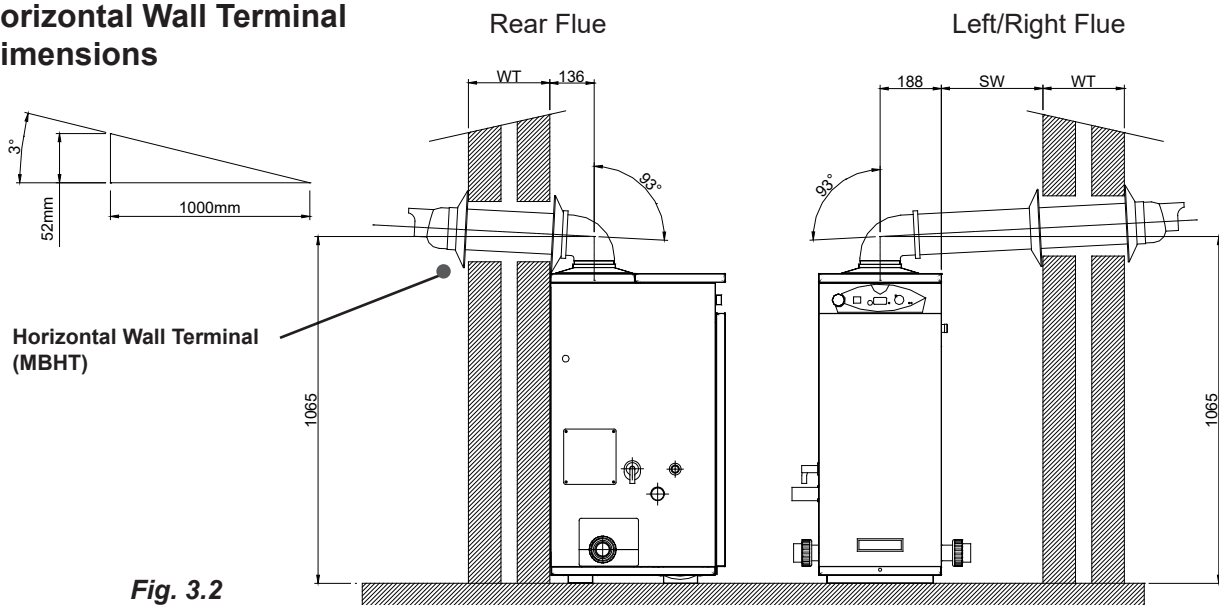

Fig. 3.2

Outdoor Terminal Dimensions

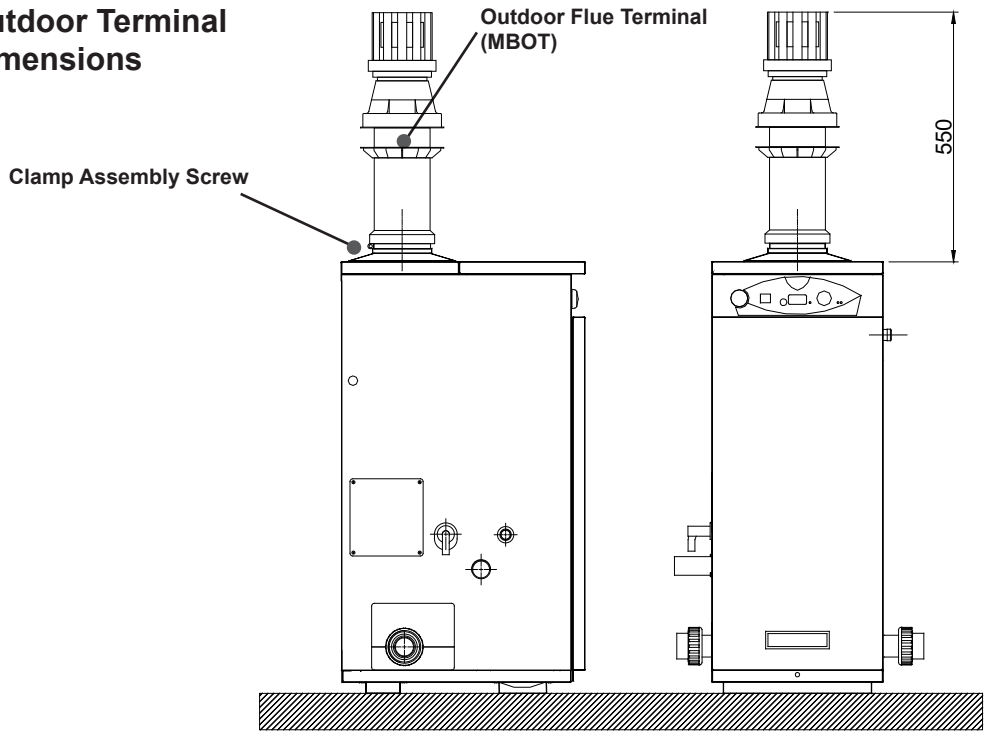

Fig. 3.3

Vertical Roof Terminal Dimensions

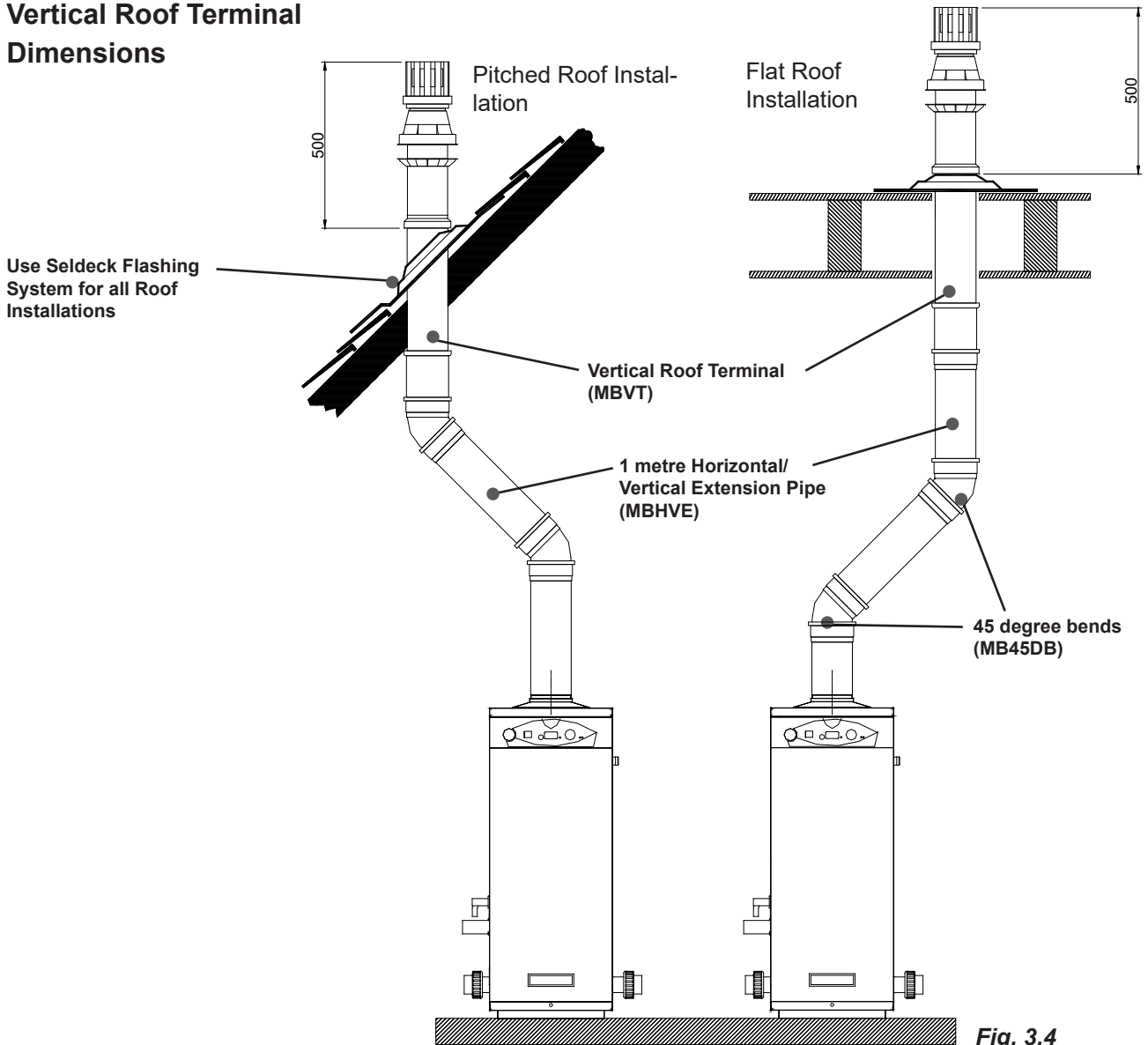

Fig. 3.4

3.6 FLUE EXAMPLES

Outdoor Terminal



Extended Horizontal Wall Terminal



Extended Vertical Roof Terminal



Horizontal Wall Terminal



Flue Kit Part Codes

Determine the type of flue system you require and choose from the list of kits available below:

Kit Code	Description	Type of Flue System		
		Outdoor Kit	Horizontal Terminal	Vertical Terminal
MBHT	Horizontal Wall Terminal	n/a	Yes	n/a
MBHVE	1 metre Horizontal/Vertical Extension Pipe	n/a	Option	Option
MBVT	Vertical Roof Terminal	n/a	n/a	Yes
MBOT	Outdoor Terminal	Yes	n/a	n/a
MB45DB	45 degree bend	n/a	Option	Option
MB90DB	90 degree bend	n/a	Option	n/a

Flue Kit Part Codes (cont.)

The Maximum Flue Equivalent Length (FEL) permitted is 20 metres, horizontal or vertical. The flue kits available below list the FEL for each component. Add up all the FEL's used in your design and check that this does not exceed 20 metres (see 3.3 for details).

Kit Code	Description	FEL Flue Equivalent Length (m)	Photo of Kit
MBHT	Horizontal Wall Terminal	3.9m	
MBHVE	1 metre Horiz./Vertical Extension Pipe	1.0m	
MBVT	Vertical Roof Terminal	3.3m	
MBOT	Outdoor Terminal	n/a	
MB45DB	45 degree bends (pair)	1.1m (per bend)	
MB90DB	90 degree bend	1.5m	

3.7 TERMINAL GUARD & ROOF TERMINAL

The flue outlet from this heater is low temperature (normally below 60°C) so a guard is only required if the terminal is in a position where it may be damaged or blocked. A suitable guard is available from: TFC Ltd. 01732 351555, Model DK6

The vertical roof terminal should be fitted in a minimum of 300mm clear unobstructed space. It is not permitted to alter the construction of the terminal, above the roof line, however the concentric section below the roof line can be altered to suit the installation.

It is recommended that:

1. The Installation of the flues are completed before connection to the heater. This will ensure that any debris from the construction of the flue does not enter the heater.
2. Whenever possible bends in vertical flues are 45 degrees.
3. Flues may be reduced in length by cutting. The inner flue pipe should be cut so it is 5 to 10mm longer than the outer Air duct. It will ease assembly if the cut edges are cleaned, chamfered and greased before assembly.

3.8 POOL WATER PLUMBING

The heater requires pool water to be flowing to operate and this is achieved via a pressure switch in the pool water flow. It must therefore be installed downstream of the filter and pump.

A typical installation is plumbed as follows:

1. The Pump outlet is plumbed to the inlet of the filter.
2. The outlet side of the filter is then plumbed to the inlet of the heater.
3. The outlet of the heater is plumbed to the return line to the pool or spa. The pump, filter and heater are plumbed in series.

If it is necessary to install a valve on the return to the pool then it is recommended that a flow switch is installed and interlocked with the heater supply. The heater must be located so that any water leaks will not damage the structure of adjacent area. The heat shunt connections of the heater, can be made in standard plastic 1½" pipe supplied demountable.

Use the pressure loss chart in 2.15 to specify a suitable pump.

Connection to the heater can be made from either left to right, or right to left, it is supplied with the 'From Pool' connection on the left. To change, undo the demount connection on the **right**, complete with blanking plates, and swap with the connections on the **left**. Ensure that the pool sensor is correctly positioned in its pocket after the change.

Pool pump flow rate

This heater has a very low resistance to pool water flow and will tolerate a wide range of flows.



**The minimum recommended flow is:
80 litres/min**

3.9 CONDENSATE CONNECTION

The direction of the plastic condensate drain pipe connection can be altered from the factory position on the left, to the right.

- Remove the blanking plate from the right hand side (*See illustration in 3.5*).
- Loosen the two screws holding the trap bracket and swivel the trap through 90 degrees.
- Secure the bracket and fit the supplied 40 mm pipe.
- Example installations are shown on next page
- Fit blanking plate to the left hand side (*See illustration on next page*).

Where possible an internal termination of the condensate discharge pipework should be used. If this is not possible external pipes should be kept as short as possible and insulated.

Where fitted in pipework that includes another trap or a pump, for example the filter backwash pipework to drain, an air break should be fitted between the heater and that pipework. Avoid connecting to a kitchen sink trap as the solids and fats in the drain will cause a blockage.

It is permissible to connect to an external gully or rain water hopper provided they connect to a combined system. The condensate should not be run into a 'grey water' recycle system.

If the condensate pipe is connected to a stack it should join not less than 450 mm above the foot of the stack. In addition it should be positioned so there no chance of cross-flow to another connection.

Installation pipework must be in 40 mm Hunter plastic pipe to a suitable drain location with a gradient of 2.5° (45mm/ metre run) minimum. If connected to another drainage trap, an air break is required between the heater drain and that trap (*See illustration on next page*).

Horizontal external pipework should be avoided if at all possible. If not possible, the pipes should be insulated or trace heated to help prevent the condensate liquid freezing.

Check during commissioning that there is a leak free working connection from the heater to the drain. The simplest way to do this is to carefully pour some water into the boiler flue and check it emerges at the drain. This will also fill the trap ready for operation.

3.9 CONDENSATE CONNECTIONS DISPOSAL METHODS

Note: Do not reduce the pipe size below the 40mm provided.

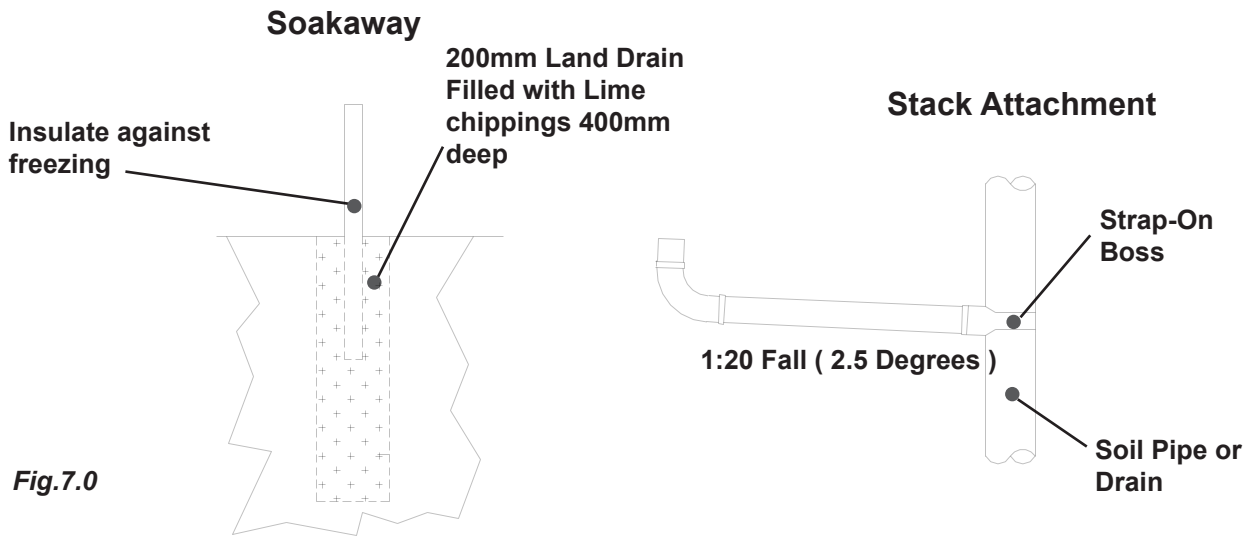

CONDENSATE SYPHON (75 MM)

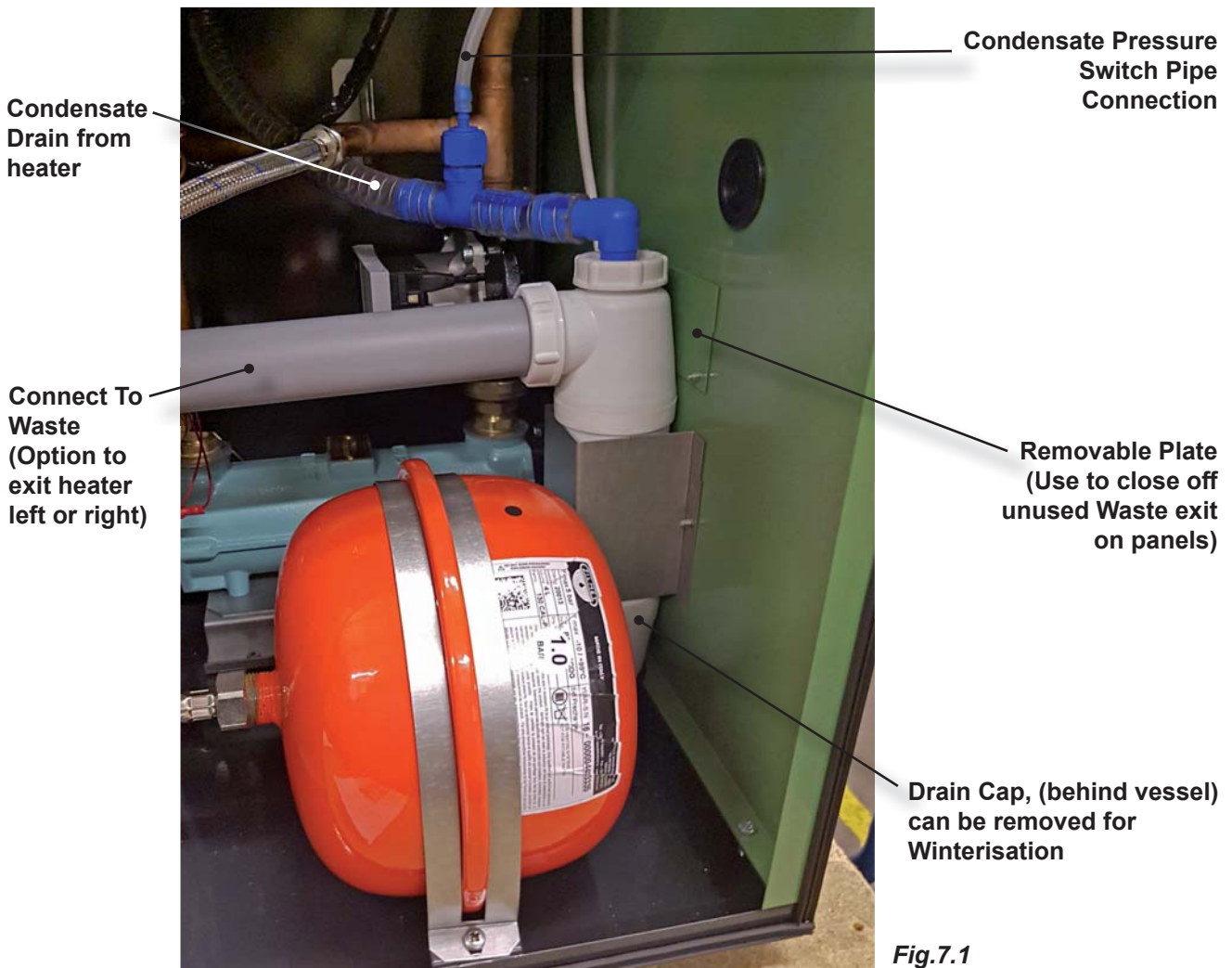

3.10 ELECTRICAL CONNECTIONS



WARNING: The appliance MUST be earthed.

All wiring for the heater and system controls MUST conform to I.E.T. Wiring Regulations, and work should be tested using a suitable meter, for Earth Continuity, Polarity, Short Circuit and Resistance to Earth.

The heater supply must be through a common isolator, a double pole 5A fused isolating switch with a contact separation of 3mm minimum on both poles. The cable used should be no less than 0.75mm² to BS.6500 PVC, 3 core, and fixed ensuring the earth connection is longer than the Live and Neutral.

Access to the heater connections is made by the removal of the front top panel and the electrical chassis cover, two screws.

The simplest and most flexible control scheme is to use a Certikin CCP01 Control Unit. This provides an electrical safety trip and timer with outputs for the heater, lights and an auxiliary voltage free output. It is pre-wired and tested and provided in a standard IP55 plastic control box.

The heater's internal wiring is illustrated in 5.4

Connections are as follows :-

4 Way Terminal	Supply Connection
	Earth
N	Mains Neutral
SL	Switched Live
L	Permanent Live

A factory installed link has been fitted between SL and L which should be removed if the heater is to have its own switched supply.

For systems using an external programmer, the electrical wiring should follow the relevant control manufacturer's recommendations, with the switched live from the controls returning to SL in the 4 way push-fit connector.

It is possible to connect several heaters together using the multiple heater kit. Details for the parts and installation of this kit are given in 3.13.

3.11 GAS CONNECTION

The 22mm copper gas connection provided can be positioned to exit the heater on either the left or the right hand side. A minimum of 19mb. (NG), 35mb (propane) 26 mbar (butane) must be available at the heater inlet, with the heater and other connected gas appliances operating at nominal load.



NB: If the gas valve test point is used there is a 2-2.5 mbar drop for the Genie 50 at full rate.

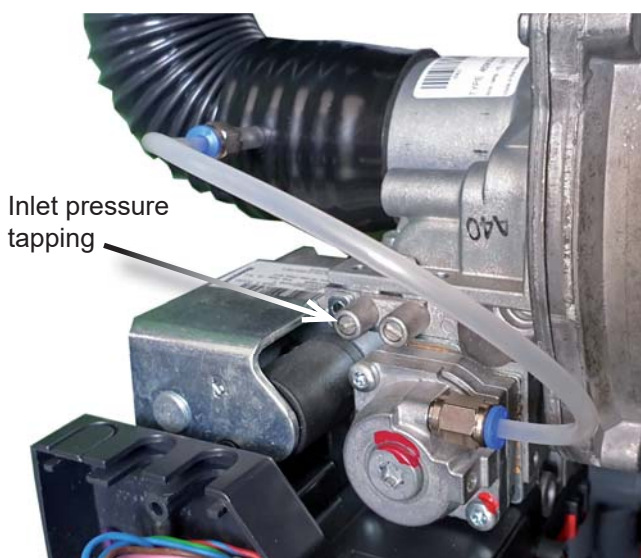

Check for gas tightness (B.S. 6891: 1988) in pipework to boiler using a manometer. Gas leakage and soundness within the heater should also be checked using sense of smell and leak detection fluid.

3.12 WALL MOUNTING KIT

Overview

The Genie models can be wall hung using the wall mounting kit.

Kit Part Code: MBWMK35/50

Instructions

- Select a suitable wall and position to mount the heater. (Note the heater weighs up to 53kg).
- Screw the top wall mounting bracket level to the wall (Fig 10.4).
- Attach the top handle bracket to the rear of the heater by using the 3 M4 screws supplied (Fig 10.5).
- Attach the bottom wall mounting bracket to the rear of the heater by using the existing 3 gold screws that fix the base to rear panel (Fig 10.5).
- Hang the heater on top wall mounting bracket locating it on the two 5mm studs.
- With the heater now in position drill and screw the bottom wall mounting bracket to the wall. See (Fig 10.4)

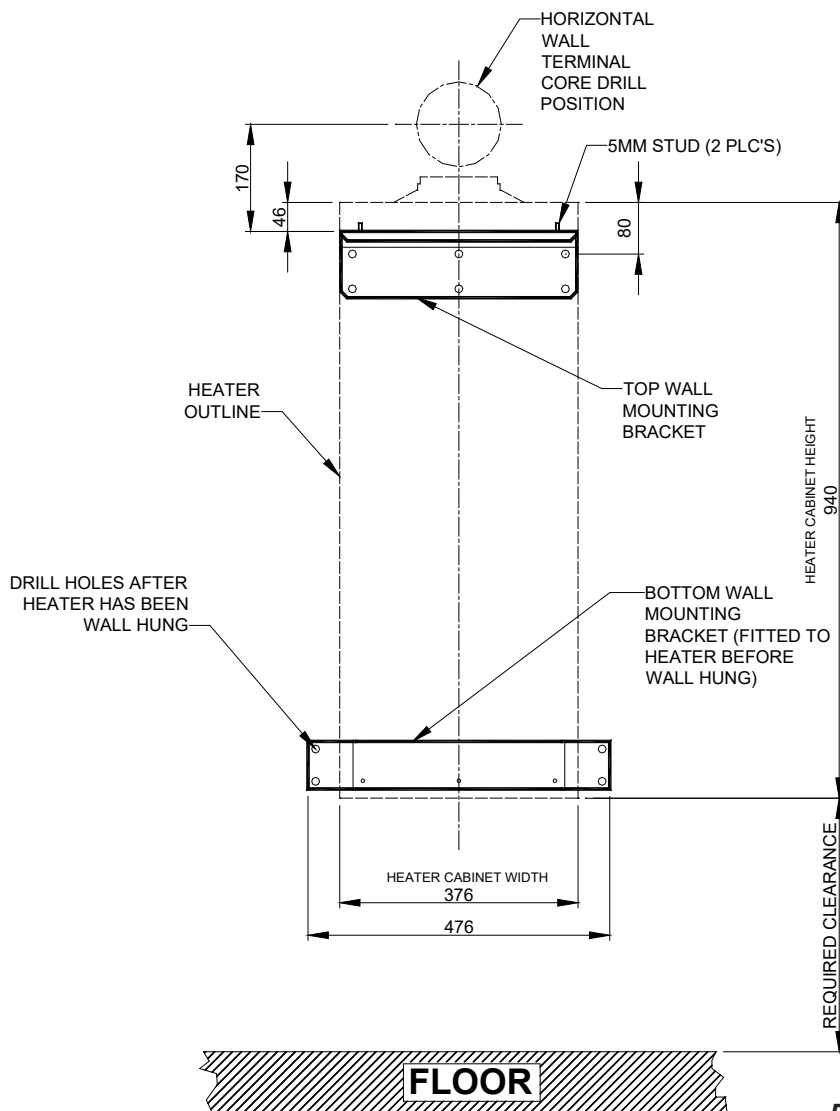
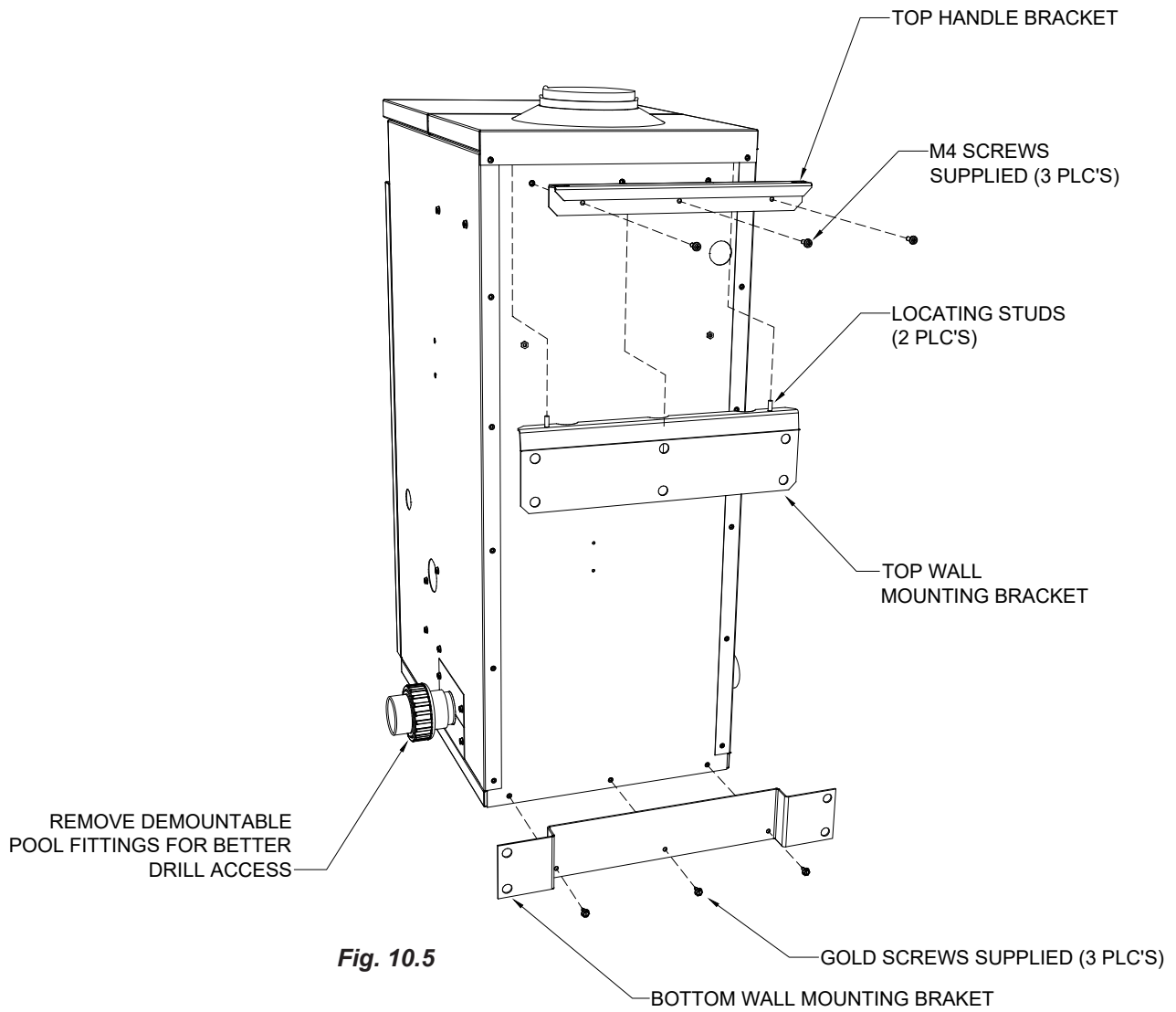

Fig. 10.4



3.13 MULTIPLE HEATER KIT

Overview

It is possible to connect together several heaters into a group cascade system and by doing so obtain a larger output with an economical and a fail-safe design. The multiple heater kit enables between two and six heaters to be connected together to automatically load share as part of a group.

This works by one heater being a master and the others being slaves. The master is set for the required pool temperature and it then controls as many of the heaters as necessary to obtain the temperature. It also equalises the operating time of every heater so they all do the same amount of work. If there is a mix of heater models, the Genie Dual should be the master.

Kit Part Codes:

2 Heaters:	MBMIK2
3 Heaters:	MBMIK3
4 Heaters:	MBMIK4
5 Heaters:	MBMIK5
6 Heaters:	MBMIK6
7 Heaters:	MBMIK7
8 Heaters:	MBMIK8

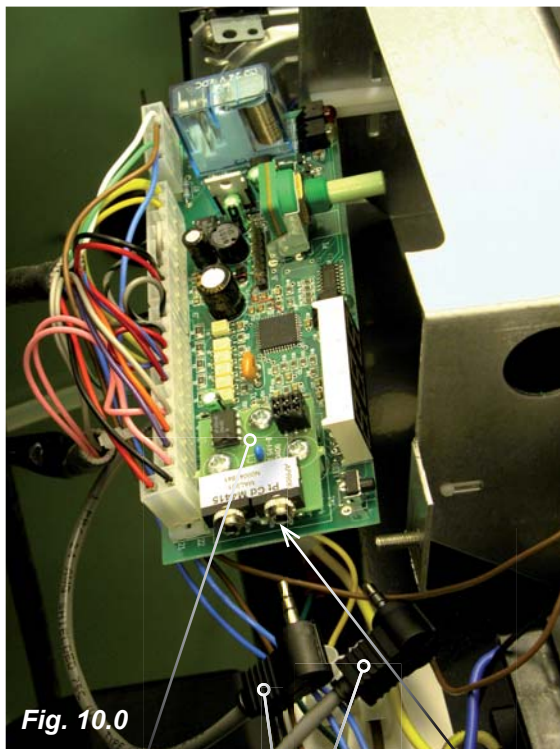

Fig. 10.0

Adapter PCB

Connectors

Interconnection Cables

Installation Instructions

- Disconnect the heater from the mains then remove the top panel and the electrical chassis cover.
- Remove pool thermostat control knob
- Remove pool thermostat PCB by removing the retaining plate and carefully slide out until fully accessible. (Fig. 10.0)
- Carefully fit the adapter kit PCB in the space behind the pool temp display on the PCB (Fig. 10.0) ensuring that the six pins on the PCB pass through the underside of the adapter PCB and, that the plastic locking pillars snap into place. Refit pool thermostat PCB and knob.
- Repeat the above steps for all the heaters.
- Using the supplied cables, pass them through the upper rear panel grommet and daisy chain the heater adapter PCBs together. The first and last heater in the 'chain' will use the terminator plugs to fill their 2 unused sockets. There are 2 different coloured terminators, they can be placed in either the first or last heater in the group. NB. ensure the connectors are fully inserted (Fig. 10.1)
- Choose which heater is to be the master and when make the rest slaves by disconnecting their pool temperature sensors. Remove the leads to the pool temperature sensor from the six way terminal strip on the electrical chassis and tie back in a safe place. (Fig. 10.2)
- Any external electrical control should only be connected to the Master, pool demand. Remove any pool demand links from the slaves.

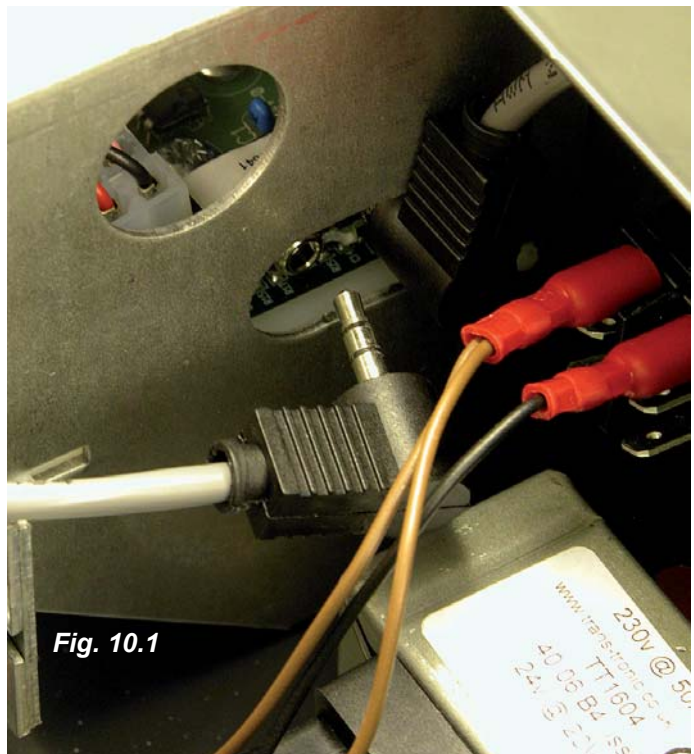

Fig. 10.1

- Turn on mains power, then switch on all the heaters. After a short self-test the master should show the actual temperature, and the slaves three dashes “---”. If a slave continues to show a display of dashes, this indicates it not correctly connected to the master, check the interconnection cable plugs are fully home.
- Replace the panels.

Operation

- Turn on all the heaters with their pool temperature controls.
- The master will show temperatures and the slaves will show “---”.
- Set the required temperature on the master and provided there is an electrical demand at the master’s pool demand connection, the heaters will operate.

Features

- A master is the only heater with a pool sensor connected, move the sensor and the master changes.
- If the master pool temperature control is turned off, none of the heaters will operate.
- If a slave’s pool temperature control is turned off it will not operate. The master will know and alter its control accordingly.
- If the master heater is in a fault situation and is unable to safely operate (i.e.in “lockout”), it should still continue to control the slaves.
- If the master control fails the ‘system’ will fail. If this should occur perform the following:

Change the master to a slave and one of the slaves to a master to enable the system to operate again.

- If a slave is in a fault condition, that slave will not operate as part of the group.
- If a slave has poor pool flow or low primary system pressure (activated by their respective pressure switches) the burner will stop immediately and the slave will be removed from the group. This is indicated by the yellow filter LED on the front control panel. The master will check approximately every 3 minutes and if the issue has been resolved the slave will be added back to the group.
- The Master display can be altered in setup mode like a single heater (*see 5.2 for details*).
- Unlike a single heater, there is no modulation of individual burners.

Displays

- The master display is just like a single heater.
- A slave will display “---” when working as part of the group. It will show all the fault conditions of a single heater, however If “P/OC” is displayed on the control panel this indicates that a communication problem with the master. Check the cables and connections.
- The pool demand LEDs work as a single heater. on when operating, off when off, and flashing if not needed by the Master.
- The warning LEDs work for all in a group, as per a single heater.

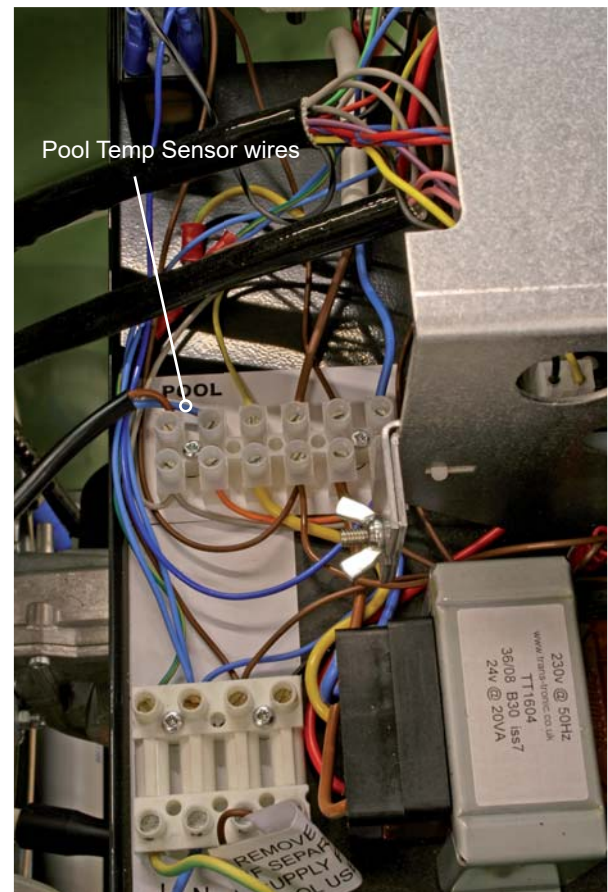

Fig. 10.2

4.0 COMMISSIONING



THIS HEATER AS SUPPLIED IS NOT FILLED WITH SUFFICIENT WATER IN THE PRIMARY CIRCUIT. DO NOT UNDER ANY CIRCUMSTANCES OPERATE THIS HEATER UNTIL THE PRIMARY CIRCUIT HAS BEEN FILLED & PRESSURISED WITH WATER & ALL AIR HAS BEEN VENTED.



IT IS ESSENTIAL TO FOLLOW THE GUIDANCE BELOW, AS PERMANENT DAMAGE COULD OCCUR TO THE PRIMARY HEAT EXCHANGER AND THIS DAMAGE WILL NOT BE COVERED BY THE WARRANTEE



This heater primary circuit contains Sentinel X500 inhibitor/anti-freeze. Minimum water should be released during filling and venting to maintain its concentration.

4.1 REMOVAL OF PRIMARY SYSTEM AIR

The elimination of air from the heat exchanger is essential to maximise the life of the heater. The following venting procedure should be followed with the heater powered, the gas supply turned off and the pool pump off:

1. Connect a pressurised fresh water supply to the water fill point directly or use the hoseslock attachment supplied.

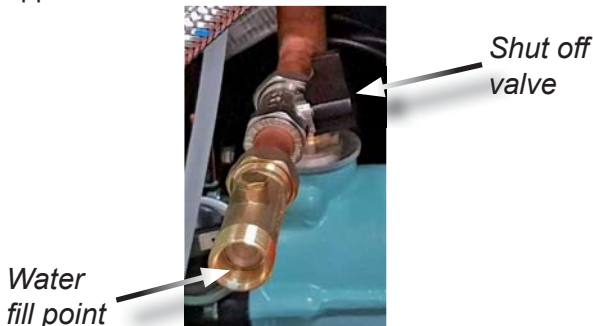

2. Referring to the pressure gauge on the front of the heater, initially open the shut off valve and pressurise the primary system to 2.9 bar.



Pressure gauge

3. Open the side vent on the right hand side of the heater and vent until water is released

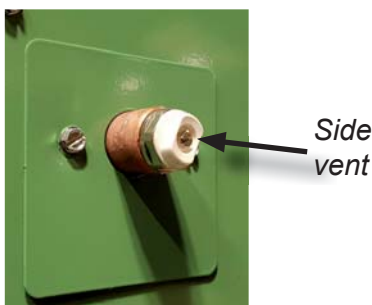

4. Re pressurise the system to 2.0 bar as necessary
5. Open the top vent of the heat exchanger by rotating the plastic section connected to the silicone tubing. Close the vent when water is released.



6. Re pressurise the system to 2.0 bar as necessary
7. Operate the internal heater pump for about 10 seconds by holding in the button located underneath the power switch on the front of the heater.

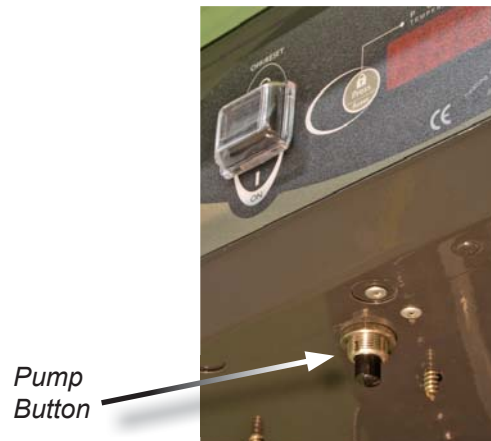

8. Vent using the top and side vents until water appears
9. Re pressurise to 1.5 bar as necessary
10. Repeat items 7 - 9 until no air can be heard when the pump button is pressed.
11. Operate the pump for repeatedly for short periods (2 seconds on - 2 seconds off) to shift any remaining air to the vent points, and vent any remaining air.
12. Operate the pump for around 1 minute to confirm that all air has been vented. The pump should operate almost silently when all air has been vented.
13. Vent further times if necessary.



ONLY when you are satisfied that the noise of air in the primary system is no longer present, should commissioning proceed with the gas supply turned ON and the pool pump operating (see following page)

4.2 PRIOR TO BURNER OPERATION

The heater control is factory set to display in Fahrenheit and work to a maximum temperature of 90°F (32°C). If a centigrade display or higher temperature 106°F (41°C) maximum is required, enter User Setup Mode. (See 4.6 for details)

The boiler is factory set for Natural Gas and fitted with automatic ignition and will start when the gas cock is open, mains is connected and the pressure switch is activated by the pool pump. (for greater detail about the internal controls see 5.1) LPG models require to be modified (See 4.4 for details).

4.3 POOL WATER PRESSURE SWITCH

The heater is protected by an adjustable pool water pressure switch that has to close before the heater will operate.



Fig. 5.0

It has an adjustment range equivalent to ± 1.5 metres. The switch is factory set for most conditions but can be altered if required:

1. Start the testing with the power switch on the front of the heater in the OFF position.
2. Turn the pool pump ON, and rotate the knurled nut clockwise until a click is heard.
3. Turn the nut anti-clockwise a quarter of a turn.
4. Turn the pump ON and OFF to check the switch operates correctly.
5. Turn the heater ON and set the temperature maximum to check that the burner is turned ON when the pool pump is turned ON and OFF when the pool pump is turned OFF



It is very important to verify that it turns off when the water flow is interrupted.

4.4 CONVERSION TO LPG

The heater can be converted on site. Natural Gas to Propane, or Propane to Butane.

Follow these steps to convert to LPG:

1. With the gas and electrical supply off, undo the three screws that hold the venturi to the gas valve.

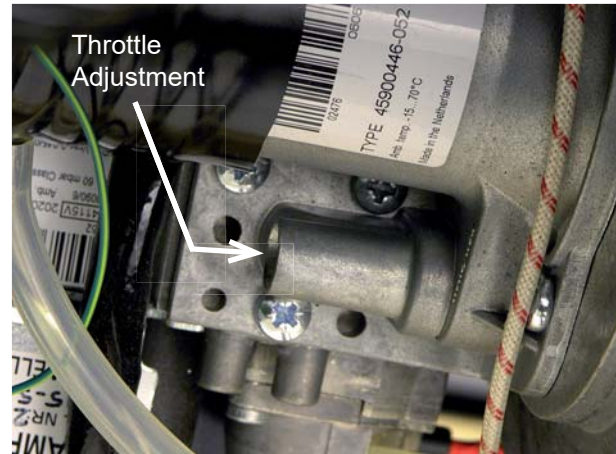

2. Allow the gas valve to drop away from the venturi.
3. Fit the conversion orifice into the rubber seal that sits in the gas valve.

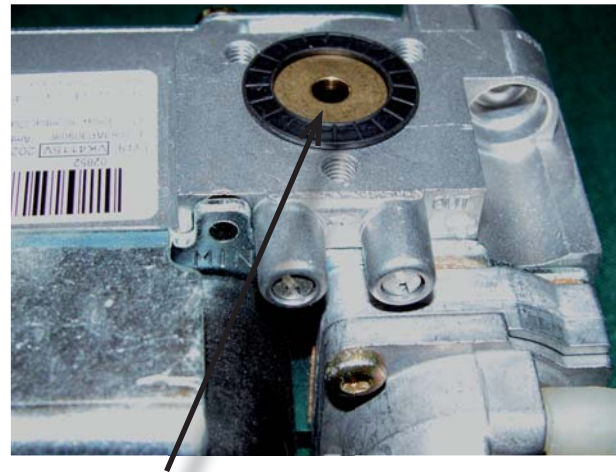

Orifice in position

4. Re-assemble the gas valve and venturi.
5. Affix the new LPG serial number data label supplied over the existing.
6. Turn gas on and check for leaks.
7. If converting an MB50S initially turn the throttle adjustment screw four turns anti-clockwise
8. Proceed to follow the guidance in 4.5 and if necessary turn the throttle screw anti-clockwise another turn until ignition is achieved.

LPG to NG Conversion

The method is as detailed above except the steps are reversed (if converting an MB50S remember to initially turn the throttle screw five turns clockwise before operating the heater).

The orifice is removed and the venturi and gas valve reassembled with just the rubber seal between them. A new serial number data plate should be obtained from the manufacturer and affixed over the existing.

4.5 COMMISSIONING THE BURNER



The gas mixture and burner off-set gas rate (minimum load rate) is preset by the manufacturer. DO NOT attempt to change the settings of the off-set governor behind the sealed cover.



DO NOT REMOVE THIS COVER

It is recommended that the condensate trap is full of water before firing. If the heater fails to light the gas it will shutdown and try again. It will repeat this a total of 3 times and then locks out. This will show as the **Red LED** lit and **'GAS'** on the display. Press the Lock/Reset button to start another 3 attempts.



Sight glass

It is possible with the front door off to see when the burner is lit through the sight glass. After the burner has been lit for a few minutes the gas rate and combustion should be checked, see the **Technical Data inside front cover** for CO² setting rates..

Briefly set the pool temperature on the heater to maximum and operate the heater at maximum output for around 5 minutes before checking the combustion with a flue gas analyser.

Flue sample point



If the CO² requires adjustment this can be done with a 4mm allen key, after having removed the dust cover of the throttle adjustment screw (see illustration below)

Throttle screw

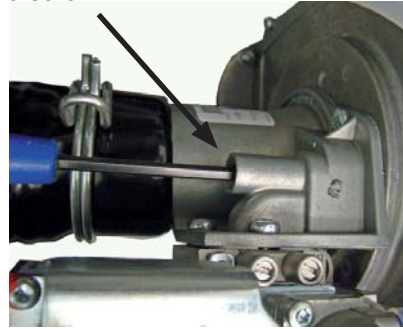

When the heater has been operating for at least 10 minutes check all joints, gas and water, for leaks, and correct where necessary. Also check for the sound of air and perform a final vent of the primary system.

For heaters operating on Natural gas: When the heater is operating at maximum input check that the gas consumption is within 5% of the data plate rating. Refer to the following table for guidance:

Rating Table (38.8Mj/m³)

kW gross	Btu/h	sec/ft³	m³/2 mins
7.5	25,590	145	0.023
12.5	42,650	87	0.039
20	68,240	55	0.062
34.6	108,055	31.5	0.107
52	177,420	21	0.161

When operating satisfactorily, complete the commissioning details on the inside back page of these instructions.



The boiler is fitted with a syphon trap that includes a blocked drain detection device. This is to safeguard the boiler from a blockage or the possible freezing of the condensate pipe work in extreme weather.

Should this happen the control will lockout and the display will show **'HI'**, as in "condensate level is high" (see 5.3 for more details).

This will have to be corrected before the heater will operate. The user should be made aware of this feature and, that in the event of blocked or frozen condensate pipework, the boiler will automatically stop functioning. It will start again as soon as the blockage has cleared.

Finally, instruct the user on heaters operation and controls.

4.6 USER SETUP MODE

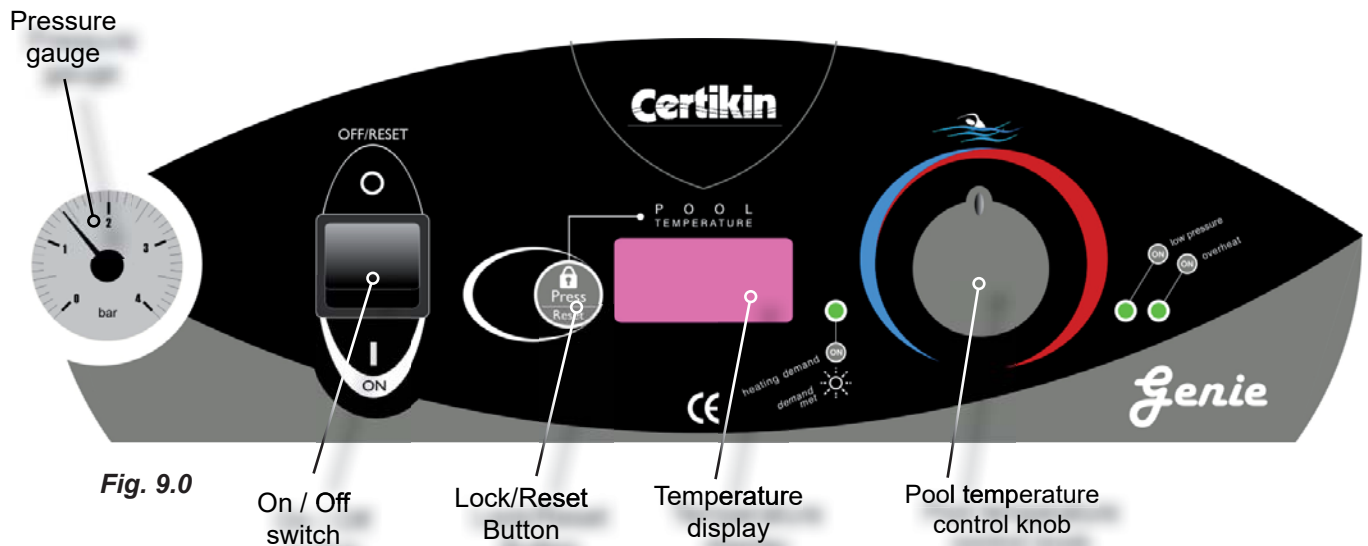



Fig. 9.0

User setup mode		Default setting	Alternative	Temperature display
1	Display units	° F = Fahrenheit	° C = Centigrade	° F or ° C
2	Maximum temp	32 °C (90 °F)	41 °C (106 °F)	PL or SPA
3	Software version			e.g 020

Switch on with the panel switch whilst pressing the Lock/Reset button  then release. The control is now in Setup Mode.

The control can now be altered by rotating the pool temperature control knob to a certain position and then pressing the Lock/Reset button  then switching off. (See Fig. 9.0)

Example:

To change from Fahrenheit to Centigrade:

Turn panel switch OFF then back ON whilst pressing the Lock/Reset  button.

Turn the pool temperature control knob until the display shows 'F'.

Press the Lock/Reset button  once and the display will show 'C'.

Switch the Panel Switch OFF then back ON again.

The control will now display in centigrade.

5.0 FAULT FINDING



BEFORE COMMENCING OR COMPLETING ANY ELECTRICAL WORK ON THE HEATER, TURN OFF THE MAINS ELECTRICITY SUPPLY

5.1 OPERATION SAFETY CONTROLS AND LOCKOUTS

This heater requires mains on both the Live (L) and switched live (SL) connection to be able to operate. It is supplied with a link wire, which can be removed if a separate heater switched live is going to be used.

This heater must have a electrical & gas supply, pool pump pressure sufficient to activate the pressure switch, all safety devices closed and the pool temperature below set point.

If all the above are correct then the ignition control will start the following ignition sequence:

1. The fan and internal pump operates to pre-purge the heat exchanger.
2. After a few seconds a spark is created at the electrode and the gas valve is opened.
3. Once the gas is ignited the flame is sensed and the spark is removed.
4. The gas valve remains open and the fan speed is then modulated to the required speed according to demand.
5. If the controls fails to establish a flame the spark will stop and the fan and internal pump will operate on to post-purge the heat exchanger.
6. After a failure to ignite or a loss of flame, the ignition sequence will be repeated up to three times, then the control will go into a permanent lockout condition and will require a manual reset to start again.

The pool thermostat control indicates the actual and set temperature of the pool and also displays all the lock-outs. The next pages detail the fault conditions, the indicators, the display and the actions required.

5.2 SETUP MODES

User mode

Turn off on the panel switch. Turn on with the power switch whilst pressing the Lock/Reset Button . The controls are now in "user setup mode" (See 4.6 for information).

Service mode

This is a special mode used to set the operation of the control and to investigate fault conditions, it is entered from user setup mode.

Rotate pool thermostat knob fully clockwise to show the software version number.

Press the Lock/Reset button  for 3 seconds. The control is now in Service Mode.

It is now possible to change some of the control's parameters. To show them, rotate the pool thermostat potentiometer. To zero or change them, press the Reset/Lock button .

To exit, turn the power Switch off then back on again.

	Service Mode Setting	Default setting	Press Reset	Display indicators
1	Pressure Log	Number of Operations	Resets to zero	Yellow LED ON
2	Unused	-	-	Red LED ON
3	Combustion Gas Log	Number of Operations	Resets to zero	Count, Red LED flashing
4	Gas Lockout Log	Number of Operations	Resets to zero	Count, Red & Yellow LED ON
5	Condensate Blocked Log	Number of Operations	Resets to zero	Count, Front Red PCB LED ON
6	Unused	-	-	Rear Red PCB LED ON
7	Hours run	0	Resets to zero	156 =1560 hrs, both PCB LEDs ON
8	Pool Temperature Offset	0.5°C (0.9°F)	Steps of 0.5°C (0.9°F)	-3.0°C to +3.0°C (-5.4°F to +5.4°F)
9	Display	td0	td1	td0 / td1

Test Mode 1 (td1).

Temperatures are displayed to 0.1°C resolution, not the normal 1°C

The display will now show each sensor temperature and cycle to the next for each press of the Lock/Reset button:

- Pool temperature as normally displayed. The Green LED will be ON
- Pool temperature is displayed to 0.1°C. The Green LED will be ON
- Heat exchanger flow temperature. The Yellow LED will flash rapidly
- Heat exchanger combustion temperature. The Red LED will flash rapidly

Rotating the potentiometer will change the set temperature. Pressing and holding the button whilst one of the temperatures is displayed will 'lock/unlock' it on the display for continuous observation.

5.3 FAULT CODES & DIAGNOSTICS

FRONT PANEL		ON PCB		EXPLANATION				
LOCK / RESET	DISPLAY	GREEN	YELLOW	RED	RED LED1	RED LED2	Flashing	
								OFF, no mains supply or failed power supply
								Operating, raising pool temperature to 28°C
								Up to temperature, 28°C
								Low pool water flow (Filter blockage?) or Low primary water pressure (check gauge on display)
								'SEr' alternating with pool temperature. Service required, working hours has reached setpoint.
								'OH2' Flue gas over temperature. Allow to cool then investigate in Engineering Mode. Reset with Button
								'GAS' Gas Control Lockout. Unable to light burner, reset with Button. OR Flue Stat tripped. Investigate cause. Reset on Flue Stat
								'HI' Condensate level high. Blocked? Clear obstruction and allow control to auto reset .

5.3 FAULT CODES & DIAGNOSTICS (CONTINUED)

FRONT PANEL		ON PCB		EXPLANATION					
					LOCK / RESET	DISPLAY	GREEN	YELLOW	RED
									'P' alternating with 'oc' = Pool sensor open circuit OR No net-work detected if a Master in a multiple heater installation 'P' alternating with 'cc' = Pool sensor short circuit
									'F' alternating with 'oc' = Heat Exchanger Flow sensor open circuit 'F' alternating with 'cc' = Heat Exchanger Flow sensor short circuit
									'H' alternating with 'oc' = Heat Exchanger Combustion sensor open circuit 'H' alternating with 'cc' = Heat Exchanger Combustion sensor short circuit
									'Err' alternating with '4' = Pool potentiometer open circuit 'Err' alternating with '5' = Pool potentiometer short circuit

For all of the above. Turn off, correct problem and turn back on again and the display and operation will be normal.

5.3 FAULT CODES & DIAGNOSTICS (CONTINUED)

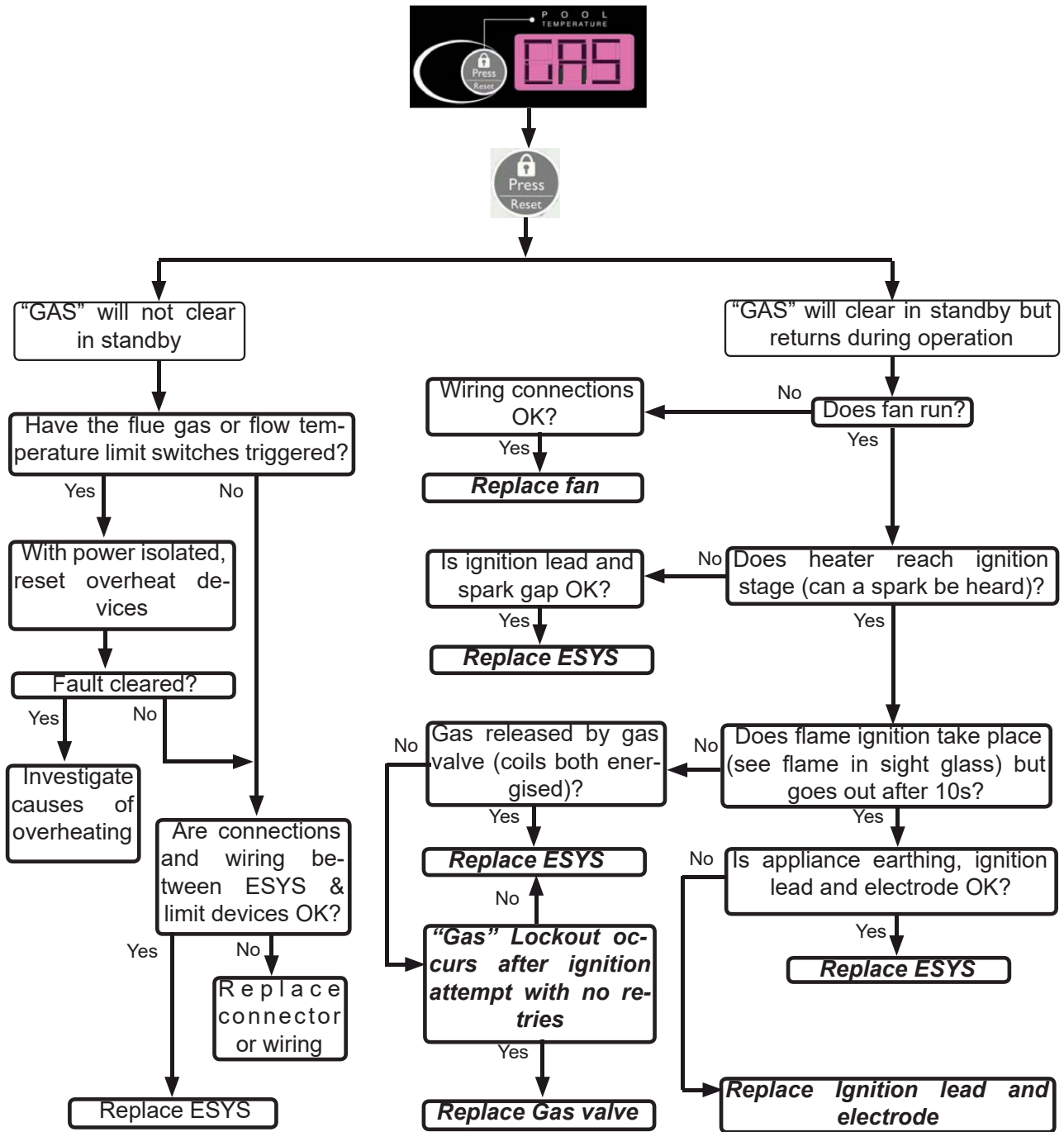

NB - A "Gas" lockout which occurs when there is no demand for heating can only be related to the two manual overheat protection devices. These are constantly monitored by the controller, even in standby mode.

NB - All non-overheat protection type faults are only monitored during the ignition process, and will occur at the end of the first 10s spark ignition period.

5.4 SCHEMATIC WIRING

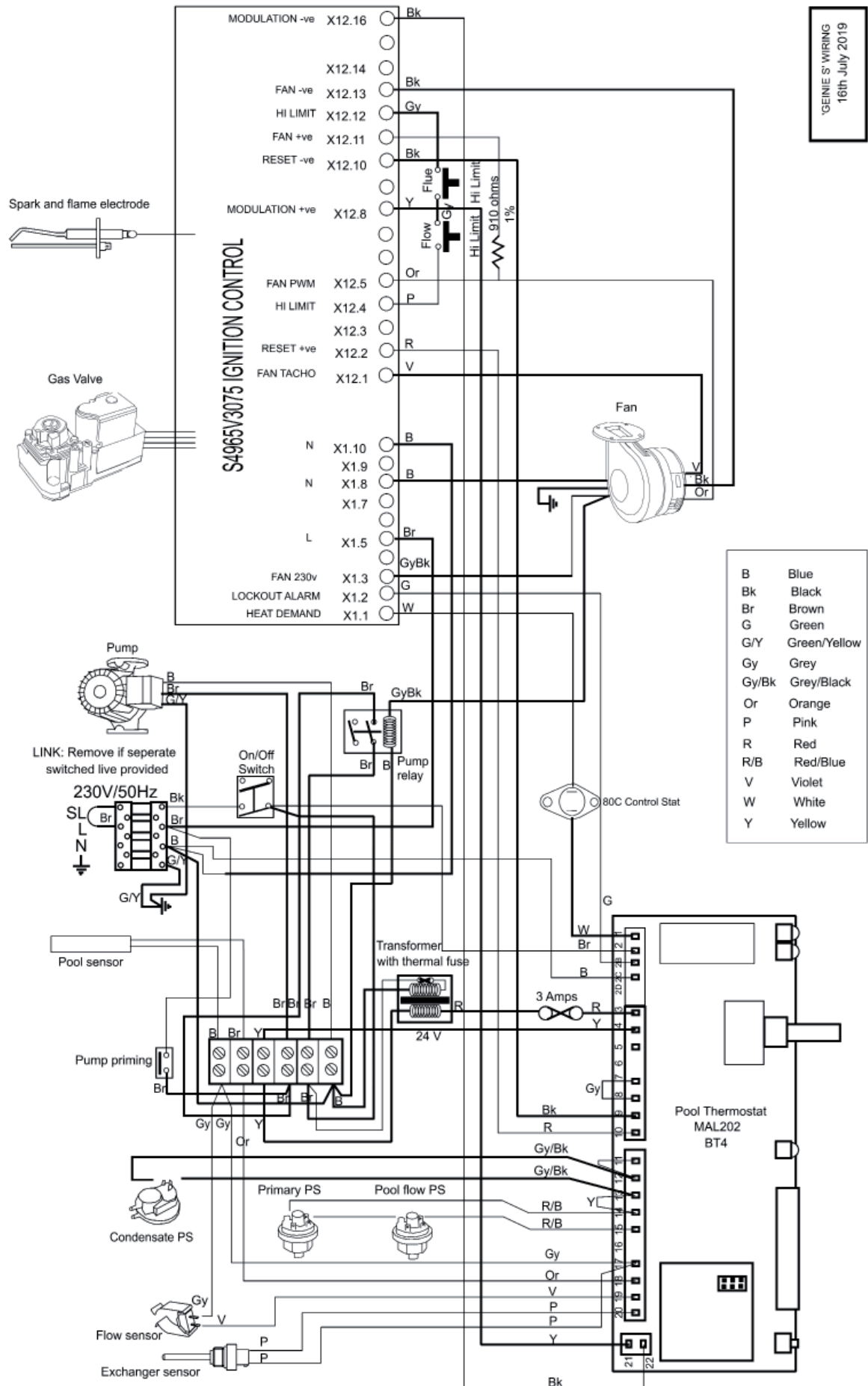

GENIE S' WIRING
16th July 2019

Fig.11.0

6.0 SERVICING



In all cases, before work commences turn off the Mains Electricity and Gas Supply.

6.1 ROUTINE SERVICING

To ensure continued efficient operation of the appliance it is recommended that it is checked and serviced at regular intervals.

The frequency of servicing will depend upon the particular installation and usage but in general every 2,000 hours of operation should be the maximum.

It is law that any service work should be carried out by Registered personnel.

1. Clean burner and combustion chamber.
2. Check condition of ignition spark and sensing probe.
3. Check boiler pipework joints for leaks.
4. Check the air duct and flue seals.
5. Check condensate syphon and pipework for leaks.
6. Check the gas rate.
7. Check the combustion CO and CO².
8. Reset the service hours counter in the control.

Follow the procedures given in the next section “Changing Components” for parts removal in addition to the following notes.

Burner & combustion chamber

To view the burner and the inside of the heat exchanger it is suggested you remove the front of the heat exchanger complete with the fan and gas valve:

- Remove door and front top panel
- Disconnect the gas elbow flange from valve.
- Unplug fan electrical connectors.
- Remove air tube from flue adapter.
- Undo cover over Ignition control connections and remove the two connectors.
- Pull off the earth lead connection on the valve & heat exchanger.
- Undo the four nuts holding the heat exchanger front and withdraw.
- Carefully inspect the black silicone seal on the inside of the burner door, for hardness or splitting. Replacement is recommended every two years, but if damaged, replace the seal immediately.
- Assembly is the reverse.
- Reset the service hours counter. (See 5.2 for details)

Spark & sense electrode

- Turn off the heater.
- Pull off the HT Lead.
- Undo the two screws retaining the electrode assembly and carefully withdraw. The spark gap should be 3.0 mm ± 0.5 mm (See Fig 12.0)
- Assembly is the reverse, ensure the gasket is correctly placed.

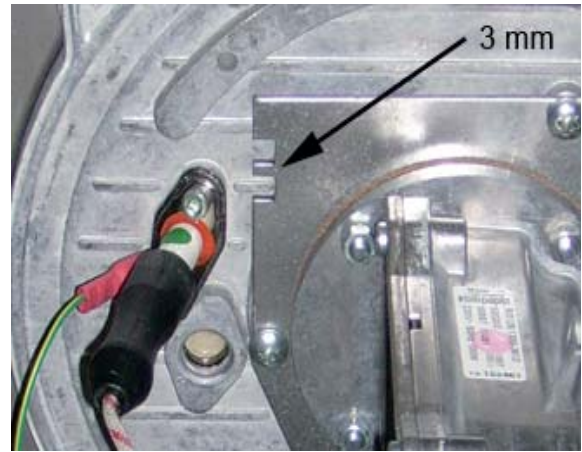

Fig 12.0

Pipework



IMPORTANT : *The Heat exchanger connections are made using O rings and should not be strained in any direction. Any strain will result in damage to the heat exchanger and will not be covered by the warranty.*

Condensate syphon

The lower bowl of the Syphon can be unscrewed, examined and cleaned.

Air duct & flue seals

A visual inspection should establish there are no leaks around any of the seals, including the flexible air duct to the venturi.

Gas rate & combustion

See Data table on inside cover for the correct values.

A combustion sample point is provided on the front of the flue adapter (see 6.4 for illustration)

6.2 CHANGING COMPONENTS



Disconnect from power supply before carrying out any electrical work

The following items can be replaced:

THE ELECTRICAL CHASSIS

To access these items first remove the front top panel and then the chassis cover.

Fuse (See 6.4 for illustration)

There is an in-line 3A fuse on the 24V supply between the transformer and the pool thermostat. The fuse holder bayonets pull apart to allow its replacement.

Transformer (See 6.4 for illustration)

The transformer includes its own, internal thermal fuse on the primary. If this has blown, establish the cause before replacing the transformer.

- Disconnect from the terminal strip and fuse holder.
- Undo the two screws holding it to the chassis and replace.

Pool thermostat (See 6.4 for illustration)

- Pull off the pool thermostat knob.
- Release rear retainer by undoing the wing nut.
- Pull off all the PCB connectors.
- Slide out the thermostat.
- Replacement is the reverse.

Condensate pressure switch (See 6.4 for illustration)

- Undo the single fixing screw.
- Pull off the two electrical connectors and transfer to the new switch. (connect to the 'C' and 'NC' connections.)
- Replacement is the reverse

Relay (See 6.4 for illustration)

- Pull off the three electrical connectors and transfer to the new relay.
- Undo the two fixing nuts and secure new relay in position.

HEATER COMPONENTS

The remainder of the parts can be accessed through the front of the heater.

Heat exchanger flow temperature sensor

This is located on the front connection to the heat exchanger. (See 6.4 for illustration)

- Un-clip the sensor from the connection.
- Transfer the push on electrical connectors to the replacement and clip back on.

Heat exchanger pool sensor

Located in a pocket in the 'From Pool' side of the secondary heat exchanger. (See 6.4 for illustration)

- Pull out the retaining wedge, and pull out the sensor.
- Disconnect from the six way terminal strip on the electrical chassis.
- Replacement is the reverse.

Pool water pressure switch

Located on the Inlet connection to the secondary heat exchanger and its removal will require the draining or isolation of the pool water in the heater. (See 6.4 for illustration)

- Pull off the electrical connectors
- Unscrew from the secondary heat exchanger.
- Replacement is the reverse.
- Adjust switch (see 4.3 for details).

Primary water pressure switch

Located on the primary flow pipe between the primary and secondary heat exchangers. (See 6.4 for illustration)

- Drain primary system
- Remove electrical connections
- Unscrew pressure switch
- Replacement is the reverse

Control thermostat

Located on the outlet connection of the heat exchanger. (See 6.4 for illustration)

- Un-clip the sensor from the connection.
- Transfer the push on electrical connectors to the replacement and clip back on.

Heat exchanger combustion temp sensor

Located on the top of the heat exchanger, on the right hand side. (See 6.4 for illustration)

- Release the electrical connector by pressing the latch and pulling up.
- Twist the sensor a quarter turn clockwise and withdraw
- Replacement is the reverse.



Ensure the O ring seal is fitted correctly to the replacement before fitting

Flue thermostat (manual reset)

This is located on the Flue Adapter. (See 6.4 for illustration)

- Pull off the electrical connectors.
- Slide out from under the clip.
- Replacement is the reverse.

Ignition control (See 6.4 for illustration)

- Undo the single screw holding the ignition control.
- Release the two electrical connectors by pressing the latch and pulling apart.
- Pull the ignition control away from the gas valve.
- Replacement is the reverse.

Gas valve (See 6.4 for illustration)

- Remove the ignition control, see above.
- Release the gas elbow by undoing the four shoulder bolts holding it to the gas valve. Remove the offset tube from the gas valve by pushing the end of the connector inwards and then pulling the pipe out. Unscrew the offset connector and transfer to the new gas valve.
- Release the gas valve from the venturi by undoing three screws.



IMPORTANT: Ensure the rubber seal (and orifice if propane) is transferred from the old Valve and placed between the venturi and gas valve before assembly.

- Replacement is the reverse.
- Fire up the heater and check for gas leaks.
- After five minutes check the rate and combustion is correct to the data table. (inside cover). Adjust using the throttle on the gas valve.

Fan (See 6.4 for illustration)

- Remove the two electrical connectors on the fan.
- Remove the two screws holding the venturi to the fan.
- Undo the four nuts holding the fan to the heat exchanger and withdraw. (See 6.4 for illustration)
- Transfer the venturi gasket to the new fan.
- Replacement is the reverse.

Venturi (See 6.4 for illustration)

- Remove the ignition control and gas valve, see above.
- Pull off the air tube (See 6.4 for illustration)
- Undo the two screws holding the venturi to the fan and remove.
- Ensure the gasket is transferred to the new venturi or positioned on the fan before positioning the replacement.
- Replacement is the reverse.
- Fire up the heater and check for gas leaks.
- After five minutes check the rate and combustion is correct. (see inside cover). Adjust using the throttle on the gas valve if required. (See 6.4 for illustration)

Pump (See 6.4 for illustration)

- Drain the primary waterside of the heater.
- Disconnect the pump mains lead from the six way connector in the electrical chassis.
- Undo the two water connections of the pump and remove.
- Transfer the mains lead to the new pump.
- Replacement is the reverse.



IMPORTANT : It is essential that all the air is removed from the heat exchanger before the heater is fired. Operating the heater which contains air inside may damage the heat exchanger and invalidate the warranty.

Expansion vessel (See 6.4 for illustration)

- Remove the single screw holding the retaining strap.
- Release the flexible hose connection to the vessel and remove it.
- Replacement is the reverse.

Heat exchanger (See 6.4 for illustration)

- Remove the expansion vessel
- Remove the spacer below the secondary heat Exchanger by removing the two screws and pulling forward.
- Release both the heat exchanger demountable connections. (See 6.4 for illustration)
- Undo the screws holding the panels around the demountable connections. (See 6.4 for illustration)
- Lower pipework away from the heat exchanger.
- Remove the front top panel and disconnect the flue thermostat connections.
- Pull the air duct and flue up and away from the heater flue adapter.
- Disconnect the heat exchanger combustion sensor by pressing the latch and pulling off.
- Remove the four screws holding the rear top panel.
- Lift the rear top panel with the flue adapter clear of the heat exchanger.
- Remove the fan, gas valve and ignition controller.
- The heat exchanger is now only retained by the two side brackets and releasing the four front screws will enable it to be pulled forward. Before releasing ensure there is support available.
- Replacement is the reverse.



IMPORTANT : In order to maintain sufficient frost protection levels it is recommended that after a drain down, the heater is re-filled with a suitable anti-freeze. The manufacturer recommends Sentinal X500 or Fernox Alpha 11

Secondary heat exchanger (See 6.4 for illustration)

- Drain the pool side sufficiently so that the heaters pool connections can be released.
- Remove the case retaining plates around the heater's pool connections.
- Drain the primary system with the drain cock provided. Ensure an air vent is open to fully release the water.
- Remove the pool sensor from the secondary heat exchanger.
- Remove the expansion vessel.
- Remove the two fixing screws holding the spacer below the secondary heat exchanger.
- Pull the space out & forwards to remove.
- Undo the primary compression connections on the secondary heat exchanger and allow it to drop off its connections and remove.
- Remove the four screws fixing the secondary heat exchanger to its mounting plate.
- Replacement is the reverse.

6.3 SPARES

Item	Mfg' Part Number	Supplier Part No
Primary heat exchanger (Genie 20 & Genie 35)	M2136	SPMBG001
Primary heat exchanger (Genie 50)	M2139	SPMBG002
Primary heat exchanger silicone door seal	M2995	SPMBG082
Primary pump	M7966	SPMBG095
Primary flow temperature sensor	M2149	SPMBG013
Primary flow temperature stat	M2667	SPMBG055
Primary flow limit stat	M0868	SPMBC009
Primary pressure switch	651284	SPCOH2/014
Primary pressure gauge	M4240	SPCOH2/003
Primary expansion vessel	M3369	SPCOH103
Secondary heat exchanger (All models)	M2745	SPMBG053
Pool water pressure switch	651284	SPCOH2/014
Pool temperature sensor	M2798	SPCOH2/002
Pool thermostat PCB	M2746	SPMBG057
Ignition control (Genie 20)	M7182	SPMBGM7182
Ignition control (Genie 35 & Genie 50)	M2141	SPMBG005
Spark & Sense Electrode	M2146	SPMBG010
HT Lead	M2142	SPMBG006
Gas valve	M2140	SPMBG004
Propane orifice (Genie 20 & Genie 35)	M2150	SPMBG014
Propane orifice (Genie 50)	M2151	SPMBG015
Fan	M2138	SPMBG003
Pump relay	M2688	SPMBG054
Condensate syphon	M2143	SPMBG007
Condensate pressure switch	M2144	SPMBG008
Flue temperature limit stat	M2875	SPMBG060

6.4 HEATER COMPONENTS ILLUSTRATIONS

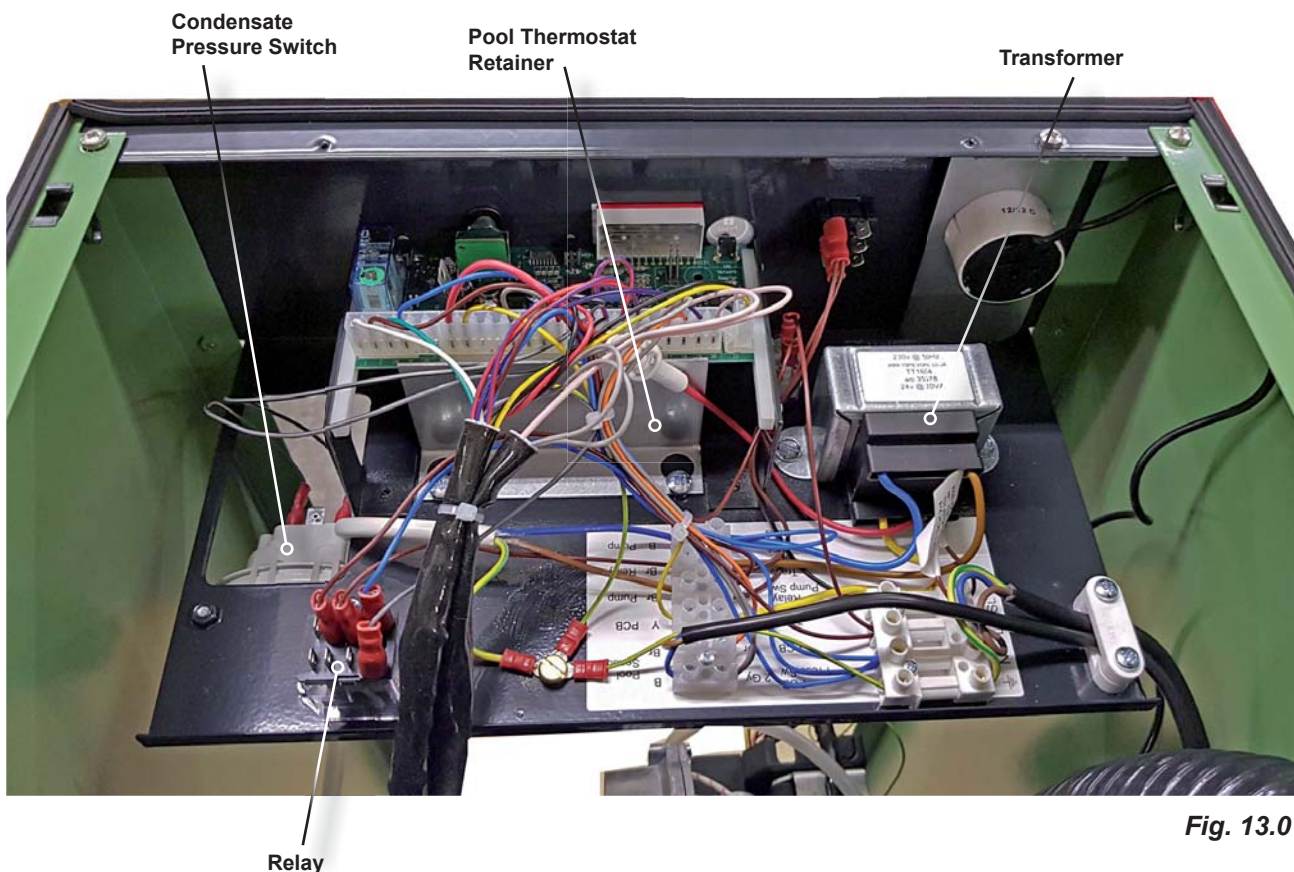
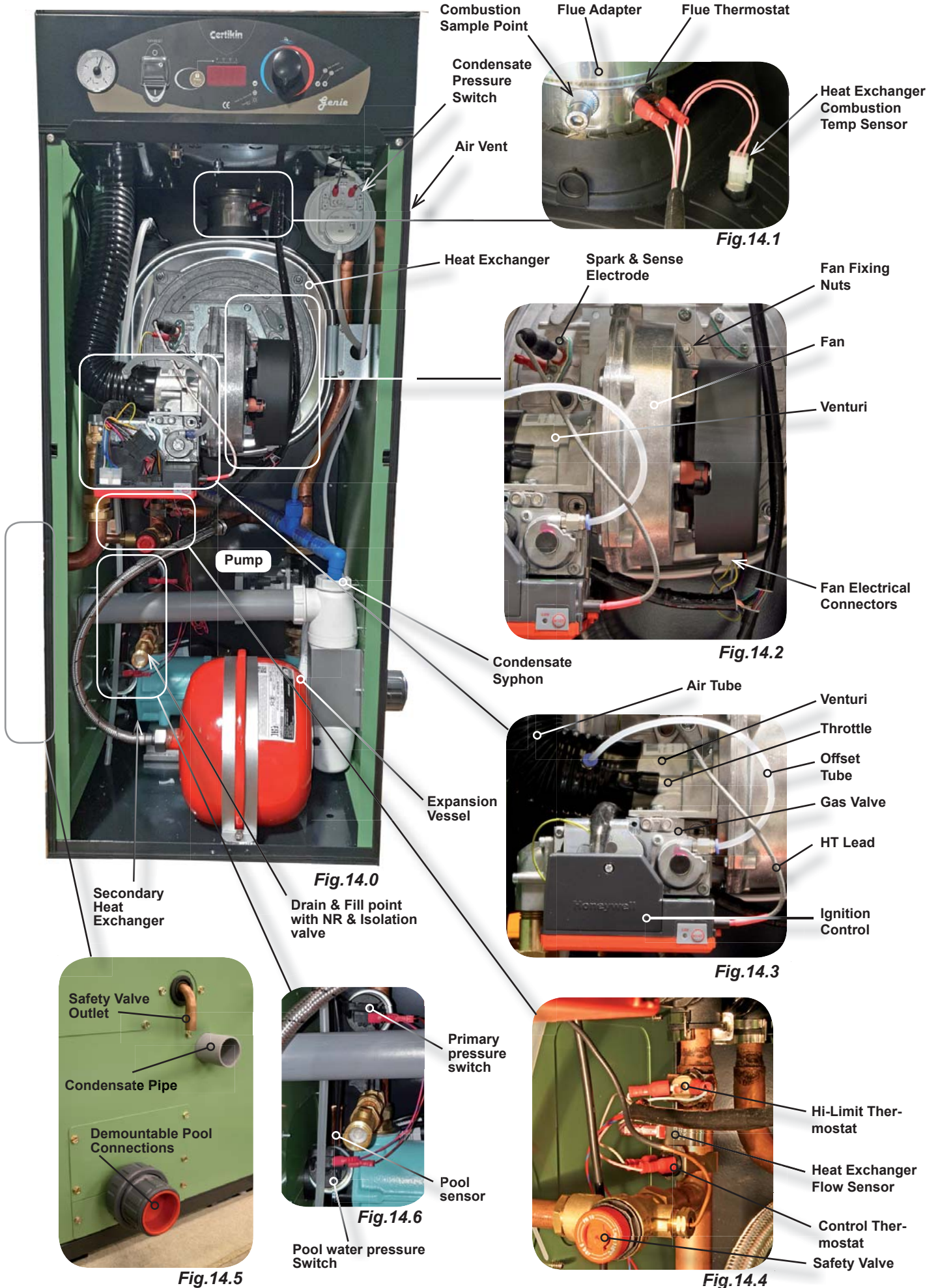

Fig. 13.0

6.4 HEATER COMPONENT ILLUSTRATIONS (CONTINUED)



7.0 INSTALLATION & SERVICE HISTORY

Circle appropriate:

Model			Gas	
Genie 20	Genie 35	Genie 50	NG	LPG

Commissioning

Installer No	Date:
Working pressure	mbar
CO ppm	CO ₂ %
Instructed User in operation?	Yes/No

Service History

Date			
Cleaned ?			
Pressure			
CO			
CO ₂			

Date			
Cleaned ?			
Pressure			
CO			
CO ₂			

Date			
Cleaned ?			
Pressure			
CO			
CO ₂			

Blank page

Certikin

Station Lane
Industrial Estate
Witney
Oxon.

Tel. 01993 778855
Fax. 01993 703407