

GS500Z Hot Sheet

Balboa Instruments System PN 54509

System Model # GS5-GS500Z-RCA-3.0k

Software Version # 38

EPN # 1785

Base PCBA - PN 54510

PCB GS500Z - PN 22015 Rev A

Base Panels

Mini – PN 52144

Lite Digital – PN 54094

Lite Duplex – PN 51676



Basic System Features and Functions

Power Requirements

- 230VAC, 1~ , 16A or 32A, 50Hz
- 3 wires (line, neutral, ground)

System Outputs (As Configured)

- 230V Pump 1, 2-Speed
- 230V Circ Pump
- 230V Ozone
- 10V Spa Light
- 230V AV (Stereo)
- 230V 3.0kW Heater

Additional Options



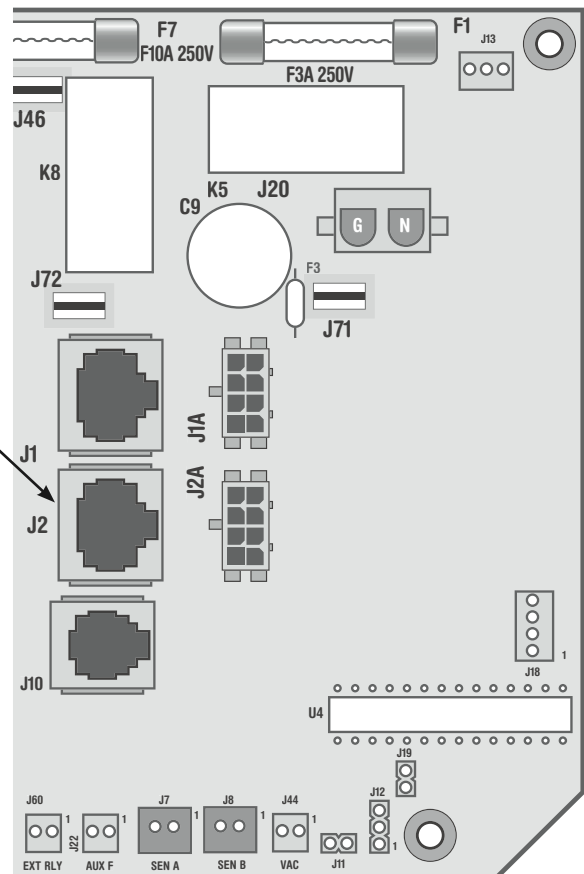

- Full Feature Dolphin Remote and Spa-only Dolphin Remote
- IR Receiver Module
Connects to terminal J1 or J2
- Ozone Generator
Connects to terminal J29
- MoodEFX Lighting
Connects to Spa Light terminal J20
- FiberEFX Lighting
Connects to Spa Light terminal J20
- Stereo System
Connects to A.V. terminal J50

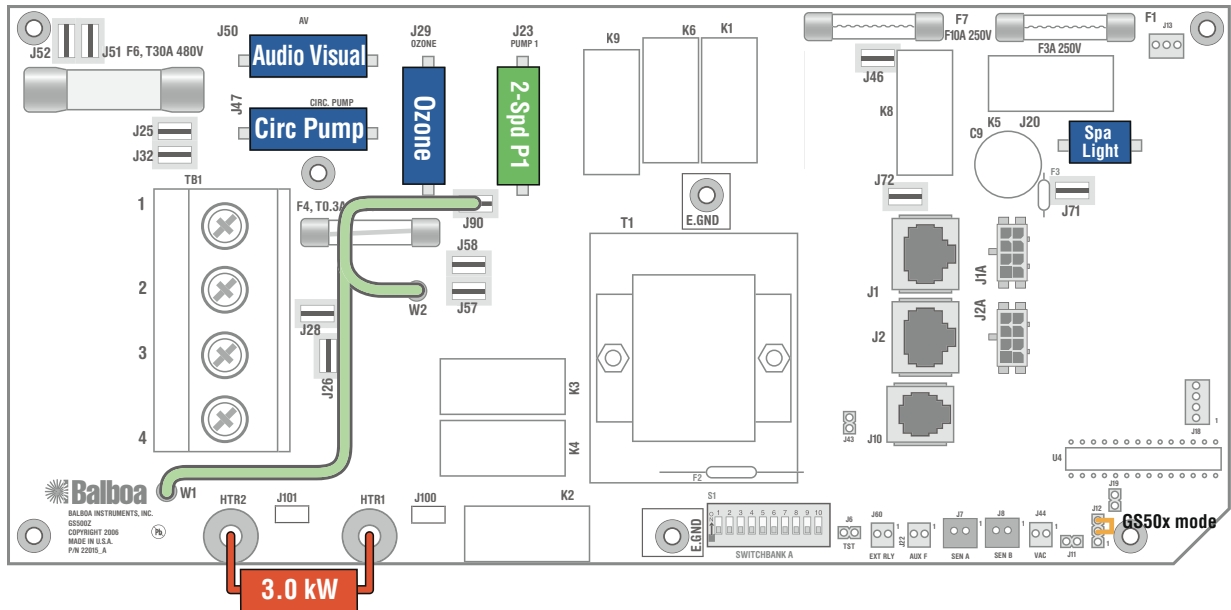





Wiring Configuration



Wiring Color Key

-  Neutral (Common) AC Connections
-  Special AC Connections
-  Line AC Connections
-  10 Volt Connections
-  Relay Control Wires

Connector Key

-  Typically Line voltage
 -  Typically Line voltage for 2-speed pumps
 -  Neutral (Common)
 -  Ground
- Note flat sides in connector

HiPot Testing Note:

Disconnect slip terminal with green wires from J90 prior to performing HiPot test. Failure to disconnect will cause a false failure of the test.

Reconnect terminal to J90 after successful completion of HiPot test.

| PCB Revision | History |
|--------------|--------------------|
| A | Production Release |
| | |
| | |
| | |

Electrical Service Configuration Options

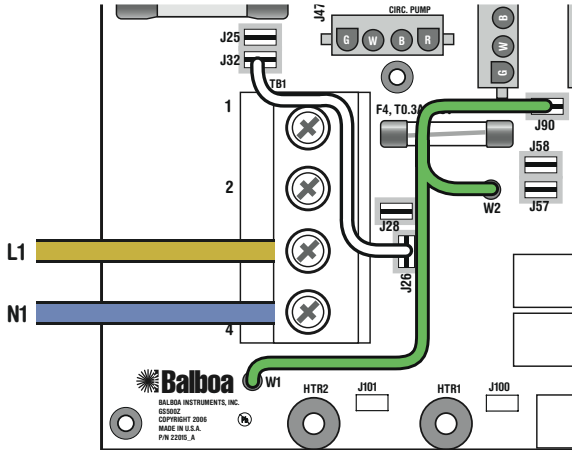

Single Service (1 x 16 Amp or 1 x 32 Amp)

This option is configured and shipped as the default.

For 1 x 32 Amp Service:

DIP Switch A10 can be ON

For 1 x 16 Amp Service:

DIP Switch A10 must be OFF

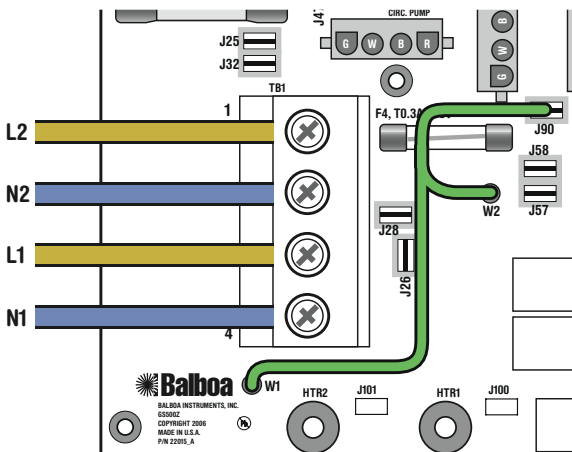

Dual Service Option (2 x 16 Amp)

Completely remove the white wire from J26 and J32.

Note: J32 and J25 are electrically identical. The white wire may be attached to either terminal before removal.

DIP Switch A10 must be ON

Configuration Options

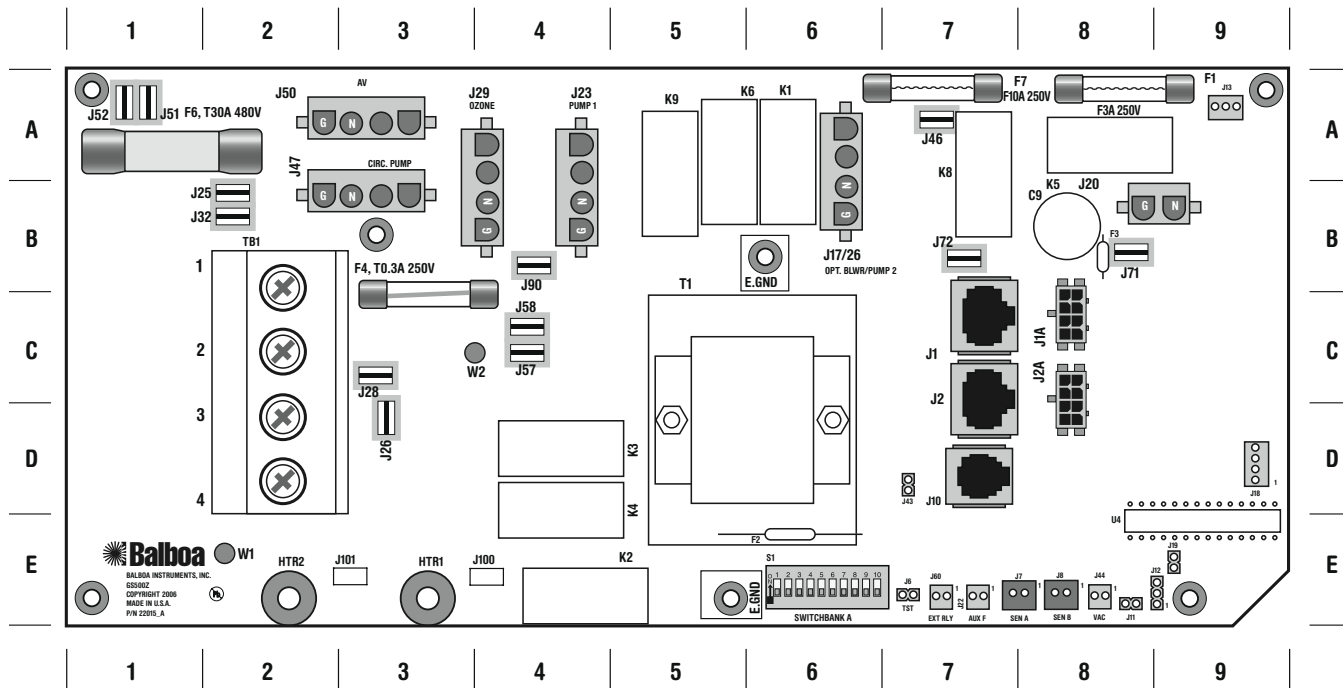

Output Features

- J50 Audio Visual (always hot - no relay)
- J47 Circ Pump
- J29 Ozone

Note: If a circ pump and ozone need a separate relay
Use the X-03 CE Expander board

- J23 2-Speed Pump 1
- J20 Spa Light

Quadrant

- 3-A
- 3-A
- 4-A
- 4-A
- 4-A
- 8-B

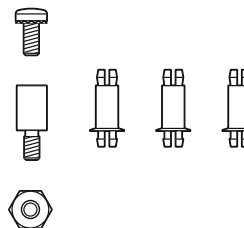

X-Mount P

PN 53933

Used for mounting any Expander Board in a plastic enclosure.
Standoffs attach to heater mounting bracket.

System can be factory configured for either a Duplex Topside Panel, a Serial Standard Panel, or a Digital Deluxe Panel.

Note: Some panels styles are not available depending on system configuration. Consult your Balboa product representative for details.

NOTE Regarding J12 (Quadrant 9-E):

When J12 on the Main Board is jumpered on pins 2 & 3, the system is in GS50xZ compatibility mode.

If J12 on the Main Board is jumpered on pins 1 & 2, the system is in GS51xZ/GS5xxSZ/GS5xxDZ compatibility mode.

Expander Options

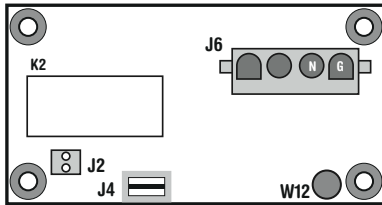

X-P CE **PN 53547**

Used for a 1-speed Pump output.

- J4 on X-P CE connects directly to Line AC using J52 or J51 on the main GS500Z PCBA.
- J2 on X-P CE connects to J60 on the main board.
- W12 on X-P CE connects directly to Neutral AC using J57 or J58 on the main GS500Z PCBA.

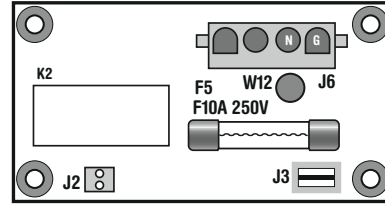

X-B CE **PN 53311**

Used for a Blower output ONLY.

- J3 on X-B CE connects directly to Line AC using J52 or J51 on the main GS500Z PCBA.
- J2 on X-B CE connects to J60 on the main board.
- W12 on X-B CE connects directly to Neutral AC using J57 or J58 on the main GS500Z PCBA.

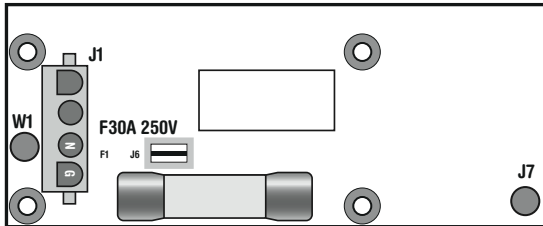

X-P231 CE **PN 55025**

Can replace the X-P CE in cases where branch circuit protection is needed for high amperage devices that would over-burden power input fuse F6 (1-A) on the main PCBA.

- J6 on X-P231 CE connects directly to Line AC using J25 or J32 on the main GS500Z PCBA, depending on AC Service Configuration.
- J7 on X-P231 CE connects to J60 on the main board.
- W1 on X-P231 CE connects directly to Neutral AC using J57 or J58 on the main GS500Z PCBA.

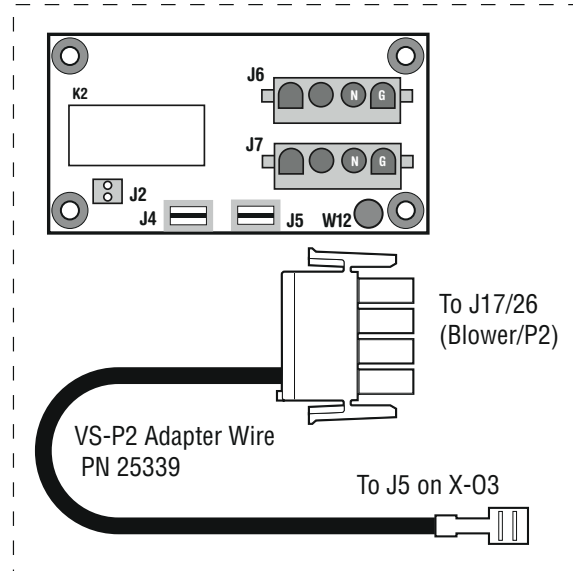

X-2SP CE Kit **PN 53985**

Adapter PN 25339 is used in conjunction with an X-03 CE to run a 2-speed Pump 2.

No Blower is available when this kit is used.

- J4 on X-03 CE connects directly to Line AC using J52 or J51 on the main GS500Z PCBA.
- J2 on X-P CE connects to J60 on the main board.
- W12 on X-P CE connects directly to Neutral AC using J57 or J58 on the main GS500Z PCBA.
- J5 on X-P CE connects J17/26 connector on the main GS500Z PCBA using adapter wire VS-P2.

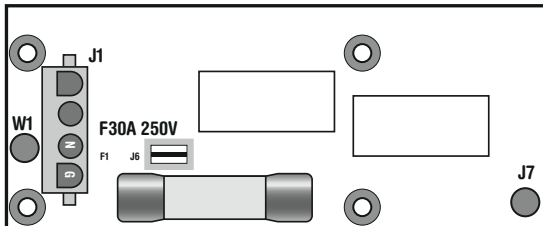

X-P332 CE **PN 55138**

Can replace the X-P CE in cases where branch circuit protection is needed for high amperage devices that would over-burden power input fuse F6 (1-A) on the main PCBA.

- J6 on X-P332 CE connects directly to Line AC using J25 or J32 on the main GS500Z PCBA, depending on AC Service Configuration.
- J7 on X-P332 CE connects to J13 on the main board.
- W1 on X-P332 CE connects directly to Neutral AC using J57 or J58 on the main GS500Z PCBA.

DIP Switches and Jumpers

SSID #
100
61
38

Switchbank A

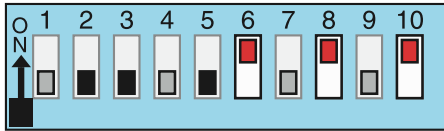

- | | |
|------------------------------|---------------------------------|
| A1, Test Mode OFF | A6, 50 Hz |
| A2, U, J, T, L | A7, Mode changes allowed |
| A3, Duplex Panel | A8, Degrees C |
| A4, Aux Freeze | A9, Circ Pump OFF |
| A5, 1-speed P1 w/Circ | A10, Low Amp mode |

GS50x Compatible

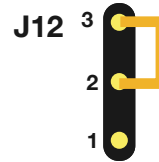

J43



DIP Switch Key

- A1 Test Mode (normally Off)
- A2 In "ON" position, Button layout will be: Jets, Light, Down, Up
..... In "OFF" position, Button layout will be: Unused, Jets, Temp, Light
- A3 In "ON" position, use Mini Panel
..... In "OFF" position, use Digital Duplex or Light Duplex panel
- A4 Aux Freeze (must be OFF)
- A5 In "ON" position, Two-speed pump 1
..... In "OFF" position, One-speed pump 1 (A9 must be On and a circ pump installed)
- A6 In "ON" position, 50Hz operation
..... In "OFF" position, 60Hz operation
- A7 In "ON" position, Standard mode only
..... In "OFF" position, Std/Ecn/Sleep mode changes allowed
- A8 In "ON" position, temperature is displayed in degrees Celsius
..... In "OFF" position, temperature is displayed in degrees Fahrenheit
- A9 In "ON" Position, 24 Hour Circ Pump with 3°F shut off
..... In "OFF" position, no circ pump
- A10 In "ON" Position, heater is disabled while any high-speed pump or blower is running (low amperage mode)
..... In "OFF" position, heater can run while any/all high-speed pumps or blowers are running (high amperage mode)

* No blower or second pump available on GS500Z models. If additional output is required, use GS501Z or higher.

Jumper Key

- J12** Jumper on Pin 1 and 2 will enable GS51x/GS5xxS/GS5xxD compatibility mode.
Jumper on Pin 2 and 3 will enable GS50x compatibility mode (Do not use with Serial or Deluxe Panels).
- J43** When jumper is placed on 2 pins during power-up, system will reset persistent memory.
Leave on 1 pin only to enable persistent memory feature.

Ozone Connections

Note: A special tool is required to remove the pins from the connector body once they are snapped in place. Check with your Balboa Account Manager for information on purchasing a pin-removal tool.

Balboa Ozone connector configuration for 230VAC 50Hz:

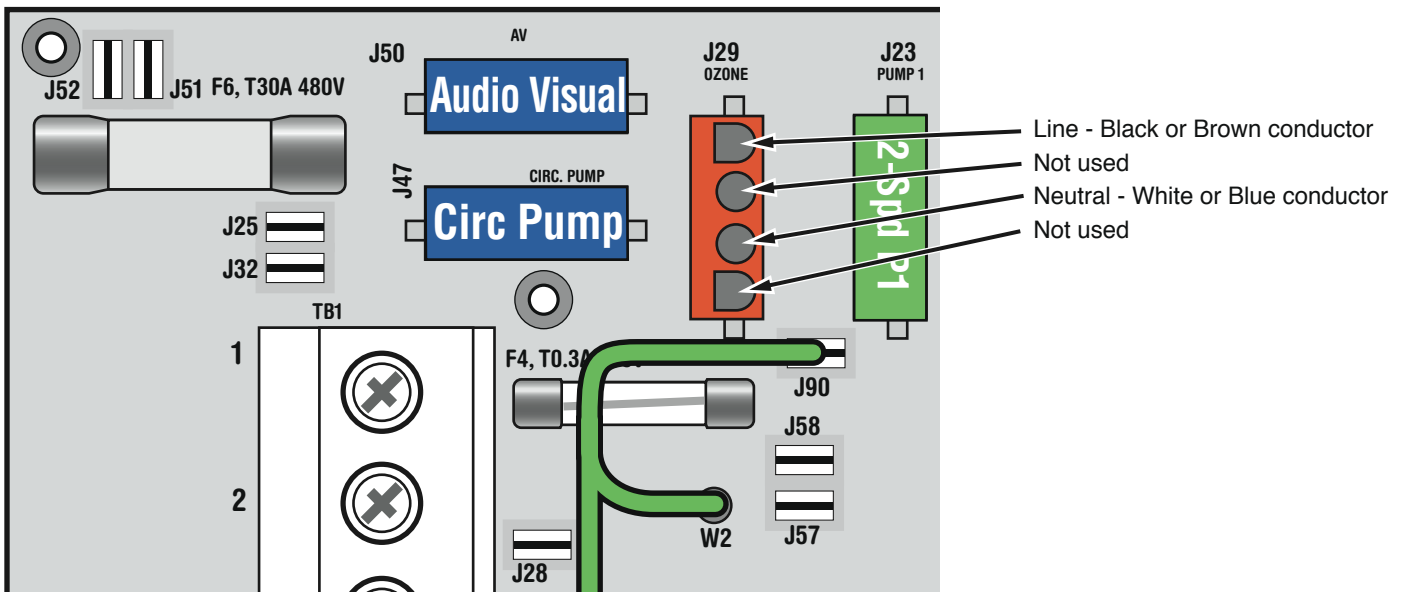
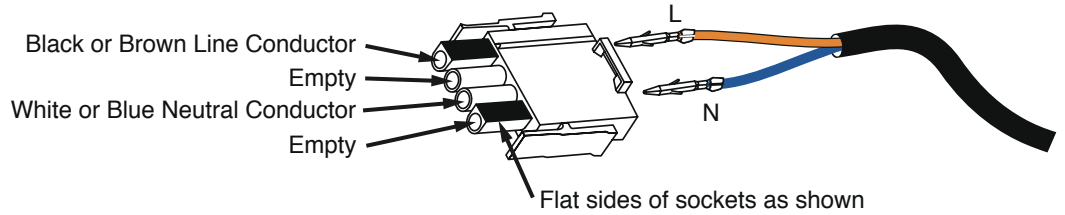

Duplex Panel Configurations



Mini Panel

PN 52144 with Overlay PN 11095

- Connects to Main Panel terminal J1

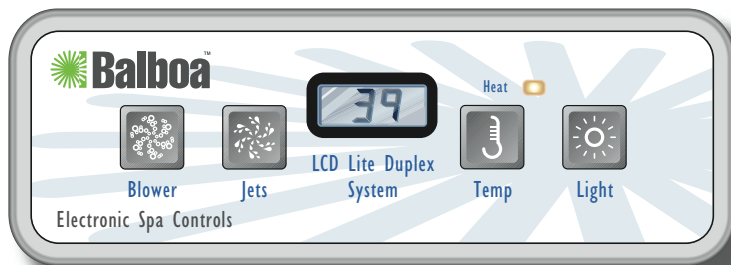

Lite Digital

PN 54094 with Overlay PN 10669

- Connects to Main Panel terminal J1

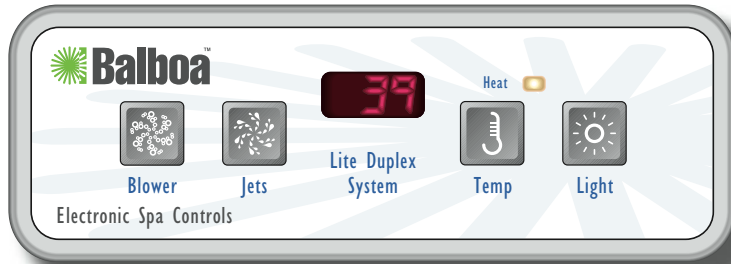

Lite Duplex

PN 51676 with Overlay PN 10671

- Connects to Main Panel terminal J1